



# SPAZIO ZERO6

**GAM**  
GONZAGARREDI  
MONTESSORI



**SPAZIO ZERO6**  
SPAZIO ZERO6

- spazio** 004  
space
- incontro**  
meeting
- crescita**  
growth
- esperienza**  
experience
- intimità**  
coziness
- relazione**  
relationship
- gioco**  
play
- scoperta**  
discovery

- 024** contenitori  
cabinets
- 040** tavoli e sedie  
tables and chairs
- 048** lab  
lab
- 052** green frame  
green frame
- 056** inside out  
inside out
- 060** pedane e pannelli  
platforms and panels
- 064** senz'angoli  
senz'angoli
- 066** skubi  
skubi
- 068** sedute morbide  
soft seats
- 070** outdoor  
outdoor



**GAM**  
GAM

- GAM 1930 - 2024** 080  
GAM 1930 - 2024
- certificazioni** 094  
certifications

- 082** selezione articoli del catalogo 0-6  
0-6 catalog - items selection





**CRESCITA**  
GROWTH



**INTIMITÀ**  
COZINESS



**ESPERIENZA**  
EXPERIENCE



**INCONTRO**  
MEETING



**RELAZIONE**  
RELATIONSHIP



**SCOPERTA**  
DISCOVERY



**GIOCO**  
PLAY

# SPAZIO SPACE

**Lo spazio di un nido, di una scuola dell'infanzia, di un polo 06 non è una semplice sequenza di ambiti funzionali, una serie di stanze da progettare e arredare. Ogni ambiente ha valore. Evoca pensieri, muove sensibilità. Proviamo a vederlo con occhi adulti ad altezza dei bambini. Costruiamo una mappa di parole, immagini, significati.**

The space of a nursery, kindergarten, primary school is not a simple sequence of functional areas, a series of rooms to be designed and furnished. Every environment has value. It evokes thoughts, it moves sensitivity. Let's try to see it with adult's eyes at children's level. Let's build a map of words, images, meanings.

# INCONTRO MEETING

**Incontro tra bambini, tra famiglie e educatori, tra casa e scuola.  
Lo spazio d'ingresso è soglia e cambiamento. Molto più  
di un semplice spogliatoio.  
È un luogo accogliente e comunicativo. Un ponte che invita a entrare.**

Meeting between children, between families and educators, between home and school.  
The entrance area is threshold and change. Much more than just a dressing room.  
It is a welcoming and communicative place. A bridge that invites to enter.



**L'ambiente accoglie e comunica.  
La scuola si racconta.  
I messaggi di insegnanti, educatori  
e famiglie rendono lo spazio  
interessante e leggibile.**

The environment welcomes  
and communicates.  
The school tells its story.  
Messages from teachers, educators  
and families make the space  
interesting and readable.



**Un angolo verde arricchisce lo spazio d'ingresso.  
Curare piccole piante stabilisce un collegamento  
tra dentro e fuori, una relazione che cresce  
intorno alla natura.**

A green corner enhances the entrance area.  
Taking care of small plants establishes a connection  
between the inside and the outside, a relationship  
that grows around nature.

# CRESCITA GROWTH

**L'ambiente è confortevole e rassicurante. A misura dei bambini.  
I più piccoli trovano un contesto adatto a loro.  
Uno spazio per crescere. Ognuno con le sue inclinazioni  
e i suoi tempi.**

The environment is welcoming and reassuring. It is child friendly.  
The little ones find a comfortable context, suitable for them.  
A space to grow. Each one with their own inclinations and times.



**Elementi morbidi di varie geometrie  
formano percorsi e fantasiose composizioni.  
Due pezzi fanno un cubo.  
Tutti i cubi sono uguali, le metà sempre diverse.  
Ricomporre i cubi è un gioco.**

Soft elements of various shapes form paths and fancy compositions.  
Two pieces make a cube.  
All cubes are the same, the halves are always different.  
Reassembling the cubes is a game.

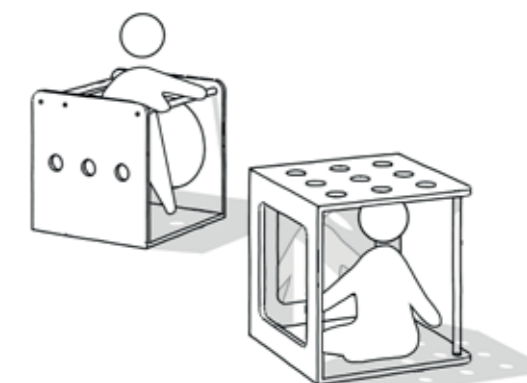

**Pannelli sulle pareti intorno a un tappeto  
e pochi oggetti formano un angolo  
per i più piccoli.  
Per gattonare, alzarsi in piedi, muovere  
i primi passi.**

Panels on the walls around a carpet and a few objects form a corner for the little ones.  
To crawl, stand up, take their first steps.

# ESPERIENZA EXPERIENCE

**Tutto lo spazio invita a conoscere e sperimentare. Ogni ambiente offre ai bambini occasioni e strumenti. Laboratori e atelier sono i luoghi privilegiati dove trovare materiali, provare tecniche, alimentare creatività.**

The whole space invites to learn and experiment. Every environment offers children opportunities and learning tools. Laboratories and ateliers are the ideal places where to find about materials, try art techniques, and fuel creativity.



**Tavoli bassi con contenitori sono basi per costruzioni. Nei vani si possono mettere materiali nuovi e sorprese. Per inventare esperimenti, giochi, composizioni.**

Low tables with compartments as construction bases. New materials and surprises can be placed in the compartments to invent experiments, games, compositions.

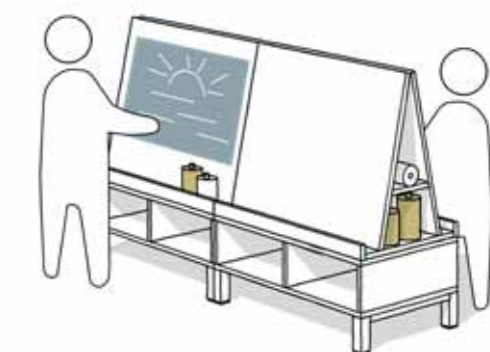

**Cavalletti bifronti invitano a disegnare sui due lati. Stabiliscono relazioni tra i bambini, accendono curiosità, provocano modi originali di disegnare.**

Double-sided easels invite to draw on both sides. They foster relationships between children, turn on curiosity, spark original ways of drawing.

# INTIMITÀ COZINESS

**Piccoli rifugi in grandi spazi.  
Nicchie, angoli, anse, isole. Posti confortevoli, dove appartarsi.  
Luoghi dove stare in pochi o da soli, per ritrovare una misura minima, intima, nella dimensione ampia della comunità.**

Small shelters in large spaces.  
Niches, corners, loops, islands. Comfortable places where to withdraw.  
Places to stay with a few or alone, to find an intimate dimension in the broader context of the community.



**Pedane curvilinee sono poli attrattivi,  
che si fanno centro di un ambiente.  
Si può disporsi intorno o salirci sopra.  
Su ogni pedana un coperchio tondo chiude  
un vano dove nascondere e trovare cose  
interessanti.**

Curvilinear platforms are center of attraction  
in the environment.  
It is possible to stand around or step onto them.  
A lid closes a compartment where to hide and find  
interesting things.



**Contenitori circolari, racchiudono  
sedute morbide intorno a un  
tappeto e formano un rifugio.  
Un atollo protetto, un piccolo  
porto che assicura tranquillità.**

Curved cabinets, enclose soft seating  
around a carpet, to create a cozy retreat.  
A protected atoll, a small port  
that ensures quietness.



# RELAZIONE RELATIONSHIP

**Relazioni tra bambini, educatori, insegnanti.  
Alcuni spazi attirano e favoriscono le relazioni.  
Sono come piccole piazze, mercati e gradonate. Luoghi di incontro  
e di scambio. Disponibili a ospitare varie attività.**

Relationships between children, educators, teachers.  
Some spaces attract and foster relationships.  
They are like small squares, markets, and steps. Places of meeting and exchange  
where to carry out various activities.



**Pannelli per disegnare, dipingere,  
esporre, giocare. Fanno delle pareti  
superfici che si possono usare.  
I bambini trovano più opportunità.  
Le stanze diventano più grandi.**

Panels for drawing, painting, displaying,  
playing. They transform walls  
into multipurpose surfaces.  
Children find more opportunities. The rooms  
get bigger.

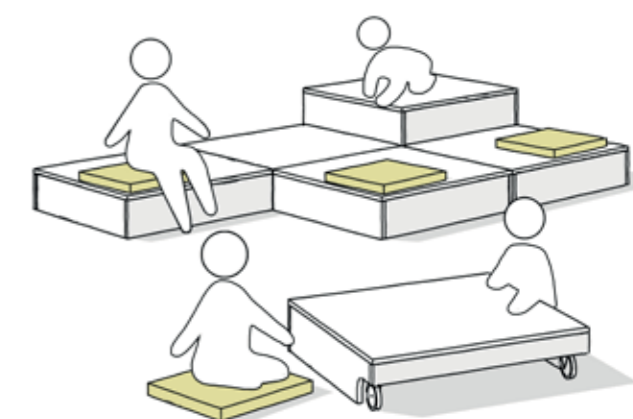

**Pedane su ruote sono parti mobili  
di un allestimento a gradoni.  
Satelliti che si spostano per comporre ambienti  
dinamici e policentrici.**

Platforms on wheels are mobile parts of a base set-up.  
Satellites that move to create dynamic and polycentric  
environments.

# GIOCO PLAY

**Il gioco interessa, sorprende, non è banale, non annoia.  
È un'attività e un'attitudine che impegna i bambini seriamente.  
Lo spazio dei giochi è un luogo desiderato, che nutre fantasia  
e creatività.**

Playing is interesting, surprising, not banal, not boring.  
It is an activity and an attitude that seriously engages children.  
The play space is desired, it nourishes imagination and creativity.

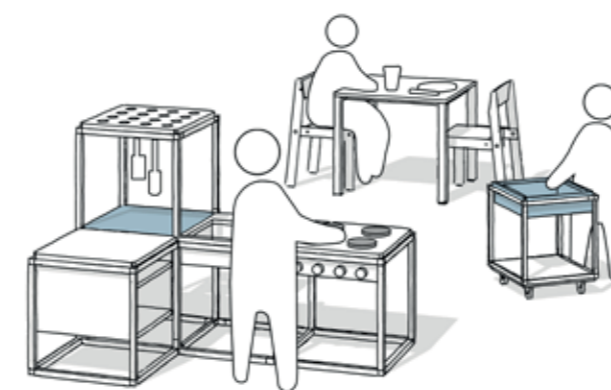

**Una piccola struttura a telaio in alluminio diventa  
una cucinetta essenziale e moderna.  
Il più tradizionale gioco simbolico si propone  
tutto nuovo alla fantasia dei bambini.**

A small aluminum frame structure becomes an essential  
and modern play kitchen.  
The most traditional symbolic game presents itself  
as completely new to children's imagination.



**Angoli di legno allestiti per funzioni  
particolari modificano lo spazio.  
Formano ambiti, individuano  
un dentro e un fuori.  
Aperture creano connessioni.  
Una finestra diventa il boccascena  
di un teatrino.**

Wooden corners set up for various  
functions modify the environment.  
They differ areas, they identify the inside  
and the outside.  
Open parts create connections.  
A window becomes the proscenium  
of a small theater.

# SCOPERTA DISCOVERY

Scoperta come metafora dello spazio esterno. Di un giardino, di un cortile, di un terrazzo.  
Luogo più vicino alla natura, che invita a trovare altri modi di muoversi, incontrarsi, giocare.  
Spazio più originale di un parco giochi, da reinventare come luogo da esplorare.

Discovery as a metaphor for outdoor space, such as a garden, a courtyard, a terrace.  
A place close to nature, suggesting new ways of moving, meeting and playing.  
The environment is more original than a playground, to be reinvented as a place to explore.

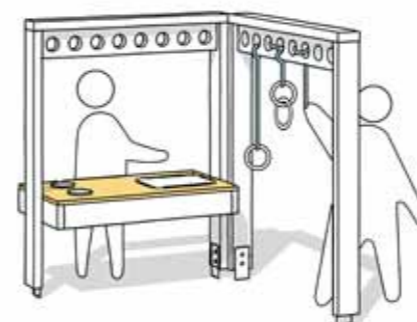

Semplici telai in legno supportano lavagne, pannelli, barre, piani, teli ombreggianti.  
Accostati, compongono strutture aperte, di varia misura e complessità.

Simple wooden frames support blackboards, panels, bars, tops and shade cloths.  
Placed side by side, they make up open structures of various sizes and complexity.

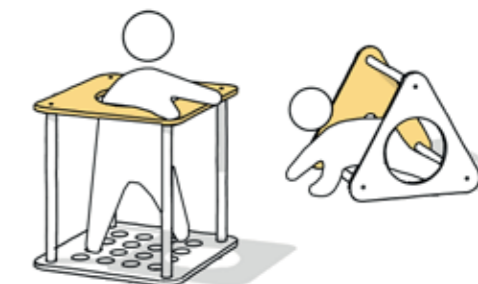

Volumi vuoti sono microtane, sostegni e occasioni di gioco per i bambini più piccoli.  
Interpretano gli oggetti inventati da Emmi Pikler in una versione originale, adatta al giardino.

Empty volumes are small dens, supports and play opportunities for younger children.  
They interpret Emmi Pikler's famous design pieces in an original version, suitable for outdoor activities.



**ENTRA NELLO SPAZIO ZERO6 GAM**  
SCAN TO ENTER GAM SPAZIO ZERO6





**CONTENITORI, TAVOLI, SEDIE**  
CABINETS, TABLES, CHAIRS



**LAB, GREEN FRAME**  
LAB, GREEN FRAME



**INSIDE OUT**  
INSIDE OUT



**PEDANE, PANNELLI, SENZ'ANGOLI**  
PLATFORMS, PANELS, SENZ'ANGOLI

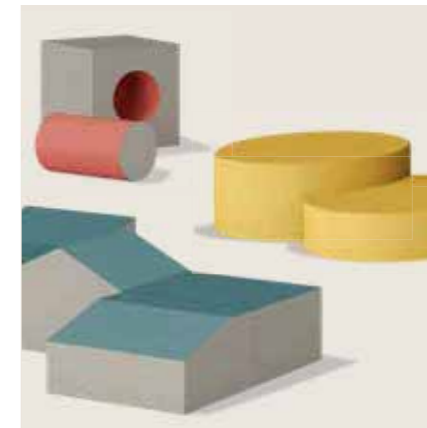

**SKUBI, SEDUTE MORBIDE**  
SKUBI, SOFT SEATS



**OUTDOOR**  
OUTDOOR



**NUOVI ARREDI SPAZIO ZERO6**  
NEW SPAZIO ZERO6 FURNITURE

**La nuova linea di contenitori è un sistema di arredi moderno e versatile. I moduli sono molto diversi dai tradizionali armadietti scolastici. Contenitori per lo più aperti, con un'ampia serie di accessori, articolano lo spazio e offrono ai bambini occasioni di attività e gioco.**

The new range of cabinets is a modern and versatile furnishing system. The modules are very different from traditional school cabinets. Mostly open cabinets, with a wide range of accessories, articulate the space and offer children opportunities for activity and play.

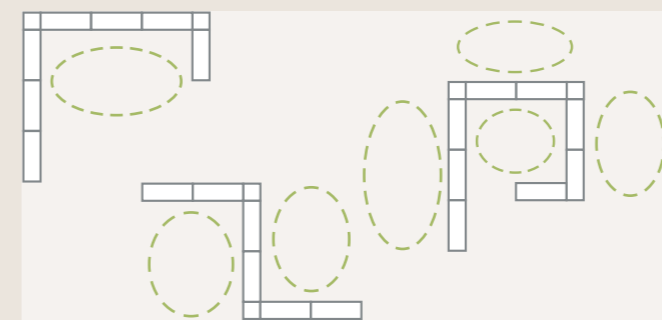

**ARREDI GENERATORI DI SPAZI**  
FURNITURE CREATING SPACES

**Soluzioni d'angolo e moduli bifronti consentono di realizzare composizioni del tutto o in parte distaccate dalle pareti, per definire individuare e caratterizzare aree.**

Corner compositions and double-sided modules allow to create partially or totally self-standing compositions to delimit different areas.

# CONTENITORI

CABINETS

**accessori  
in nobilitato betulla**  
birch melamine accessories

**cassa  
in nobilitato bianco latte**  
milk white melamine structure

**divisori in nobilitato betulla**  
birch melamine dividers

**base metallica bianco latte  
su piedi o su ruote**  
milk white metal base on feet or castors



**cassa in nobilitato  
bianco latte**  
milk white melamine structure

**ripiano in nobilitato betulla**  
birch melamine shelf

**ante in nobilitato betulla**  
birch melamine doors

**maniglia incassata  
bianco latte**  
milk white recessed handle

**base metallica bianco latte  
su piedi o su ruote**  
milk white metal base on feet or castors

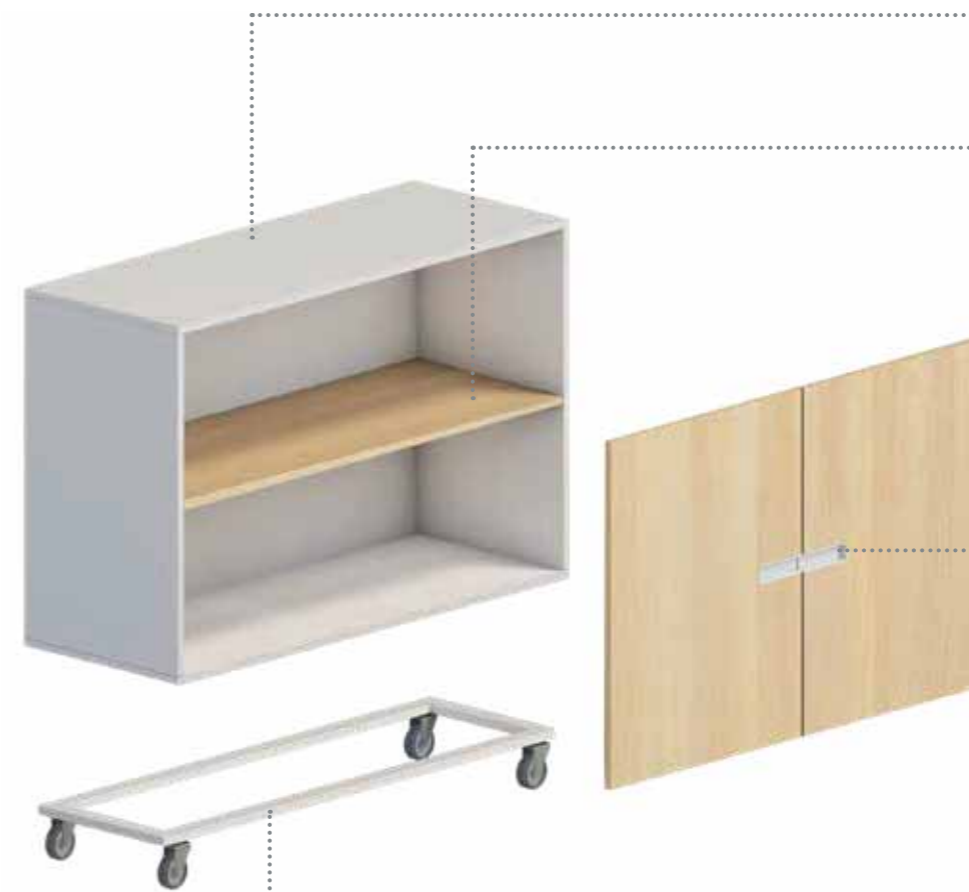

**Il nuovo sistema è caratterizzato da elementi e materiali ben riconoscibili. Volumi bianchi. Divisori, ripiani, ante e accessori betulla. Basi metalliche. Tutte le componenti garantiscono resistenza, durata, sicurezza. Il design lineare è adatto a ogni contesto.**

The new cabinet system is characterized by easily recognizable elements and materials. White volumes. Birch dividers, shelves, doors, and accessories. Metal bases. All components guarantee resistance, durability, and safety. The linear design is suitable for any context.



**La base dei contenitori è un telaio metallico su piedi o su ruote. Su richiesta può essere uno zoccolo in tinta.**

The base of the cabinets is a metal frame on feet or castors. On request, the base can be a matching plinth.

## FINITURE E COLORI FINISHES AND COLORS

**Le componenti principali del sistema hanno finiture bianche e betulla come indicato. Due accessori particolari - top green e top biblio - sono disponibili solo in tre colori di laccatura.**

The main components of the cabinet system have milk white and birch finishes. Two accessories - green top and biblio top - are available in three lacquering colors.

**cassa  
structure**

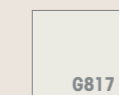

G817

**base metallica  
metal base**

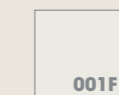

001F

RAL 9002

**divisori, ripiani, ante  
dividers, shelves, doors**

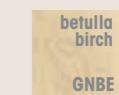

GNBE

**top green, top biblio  
green top, book top**

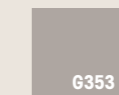

G353



G354



G352

**altri accessori  
other accessories**

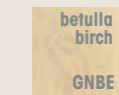

GNBE

# CONTENITORI ACCESSORI

CABINETS ACCESSORIES



## ACCESSORI DEI CONTENITORI

cabinets accessories

Accessori da sovrapporre ai contenitori base richiamano l'interesse dei bambini e sostengono attività. L'arredo dà vita allo spazio.

Accessories to be placed on top of cabinets attract children's interest and promote activities. The furniture brings life to space.



**TOP ESPOSITORE**  
display top

80x45xh21 cm  
120x45xh21 cm

**GAM620403**  
**GAM620503**



**TOP PASSANTE**  
open back top

80x45xh21 cm  
120x45xh21 cm

**GAM620401**  
**GAM620501**



**TOP PASSANTE ALTO**  
open back top - high

80x45xh60 cm  
120x45xh60 cm

**GAM620402**  
**GAM620502**



**TOP DISEGNO**  
drawing top

80x45xh60 cm  
120x45xh60 cm

**GAM620406**  
**GAM620506**



**TOP DISEGNO BIFRONTE**  
double-sided drawing top

80x45xh60 cm  
120x45xh60 cm

**GAM620407**  
**GAM620507**



**TOP ESPOSITORE ALTO**  
display top - high

80x45xh60 cm  
120x45xh60 cm

**GAM620404**  
**GAM620504**



**TOP GREEN**  
green top

80x45xh21 cm  
120x45xh21 cm

**GAM620405**  
**GAM620505**



**TOP BOOK**  
book top

80x45xh60 cm  
120x45xh60 cm

**GAM620408**  
**GAM620508**



**PANNELLO A PARETE**  
wall panel

80xh37 cm  
120xh37 cm  
80xh58 cm  
120xh58 cm

**GP0945201**  
**GP0945202**  
**GP0945101**  
**GP0945102**

## DIMENSIONI

SIZES

Altezze, larghezze e profondità dei contenitori e degli accessori sono coordinate per comporre un sistema modulare che permette di realizzare infinite composizioni.

Cabinets and accessories heights, widths, and depths are coordinated in a modular system that allows infinite compositions.

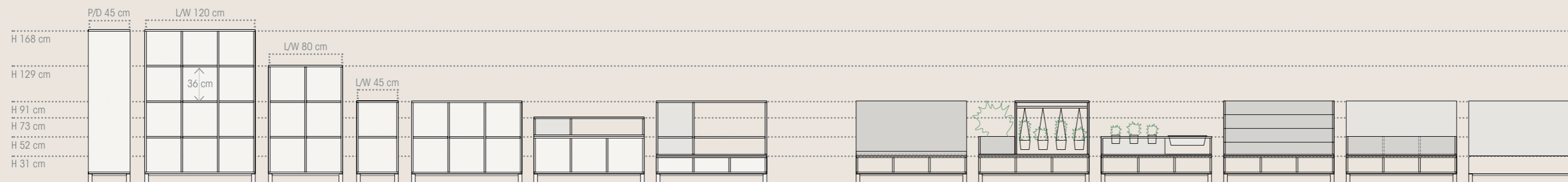







# CONTENITORI

CABINETS

## ANGOLI | CORNERS

	L/W 45 cm	
<b>COLONNA 1 CASELLA</b> 1-compartment column H 31 cm		su piedi on feet <b>GAM620000</b>
		senza piedi without feet <b>GAM620001</b>
<b>COLONNA 1 CASELLA</b> 1-compartment column H 52 cm		su ruote on castors <b>GAM620002</b>
		senza piedi without feet <b>GAM630001</b>
<b>COLONNA 2 CASELLE</b> 2-compartment column H 91 cm		su piedi on feet <b>GAM630002</b>
		senza piedi without feet <b>GAM600800</b>
<b>COLONNA 2 CASELLE</b> 2-compartment column H 91 cm		su ruote on castors <b>GAM600801</b>
		senza piedi without feet <b>GAM600802</b>
<b>COLONNA 3 CASELLE</b> 3-compartment column H 129 cm		su piedi on feet <b>GAM601900</b>
		senza piedi without feet <b>GAM601901</b>
<b>COLONNA 3 CASELLE</b> 3-compartment column H 129 cm		su ruote on castors <b>GAM601902</b>
		senza piedi without feet <b>GAM601901</b>
<b>COLONNA 4 CASELLE</b> 4-compartment column H 168 cm		su piedi on feet <b>GAM603200</b>
		senza piedi without feet <b>GAM603201</b>

## CONTENITORI | CABINETS

	L/W 80 cm		L/W 120 cm	
<b>CONTENITORE A CASELLE</b> open cabinet H 31 cm H 19 cm <b>senza piedi</b>   without feet		su piedi on feet <b>GAM620100</b>		su piedi on feet <b>GAM620200</b>
		senza piedi without feet <b>GAM620101</b>		senza piedi without feet <b>GAM620201</b>
		su ruote on castors <b>GAM620102</b>		su ruote on castors <b>GAM620202</b>
<b>CONTENITORE A GIORNO</b> open cabinet H 52 cm H 40 cm <b>senza piedi</b>   without feet		su piedi on feet <b>GAM630100</b>		su piedi on feet <b>GAM630400</b>
		senza piedi without feet <b>GAM630101</b>		senza piedi without feet <b>GAM630401</b>
		su ruote on castors <b>GAM630102</b>		su ruote on castors <b>GAM630402</b>
<b>CONTENITORE A CASELLE</b> open cabinet H 52 cm H 40 cm <b>senza piedi</b>   without feet		su piedi on feet <b>GAM630200</b>		su piedi on feet <b>GAM630500</b>
		senza piedi without feet <b>GAM630201</b>		senza piedi without feet <b>GAM630501</b>
		su ruote on castors <b>GAM630202</b>		su ruote on castors <b>GAM630502</b>

## L/W 80 cm | L/W 120 cm

**CONTENITORE A GIORNO PASSANTE**  
open cabinet (half open back)  
H 91 cm  
H 79 cm **senza piedi** | without feet



su piedi  
on feet **GAM600000**  
senza piedi  
without feet **GAM600001**  
su ruote  
on castors **GAM600002**



su piedi  
on feet **GAM610000**  
senza piedi  
without feet **GAM610001**  
su ruote  
on castors **GAM610002**

**CONTENITORE A GIORNO**  
open cabinet  
H 91 cm  
H 79 cm **senza piedi** | without feet



su piedi  
on feet **GAM600100**  
senza piedi  
without feet **GAM600101**  
su ruote  
on castors **GAM600102**



su piedi  
on feet **GAM610100**  
senza piedi  
without feet **GAM610101**  
su ruote  
on castors **GAM610102**

**CONTENITORE A CASELLE**  
open cabinet  
H 91 cm  
H 79 cm **senza piedi** | without feet



su piedi  
on feet **GAM600300**  
senza piedi  
without feet **GAM600301**  
su ruote  
on castors **GAM600302**



su piedi  
on feet **GAM610300**  
senza piedi  
without feet **GAM610301**  
su ruote  
on castors **GAM610302**

**CONTENITORE A CASELLE PER CASSETTI IN PLASTICA**  
open cabinet for plastic drawers  
H 91 cm  
H 79 cm **senza piedi** | without feet



su piedi  
on feet **GAM600400**  
senza piedi  
without feet **GAM600401**  
su ruote  
on castors **GAM600402**



su piedi  
on feet **GAM610400**  
senza piedi  
without feet **GAM610401**  
su ruote  
on castors **GAM610402**

**CONTENITORE AD ANTE**  
cabinet with doors  
H 91 cm  
H 79 cm **senza piedi** | without feet



su piedi  
on feet **GAM600500**  
senza piedi  
without feet **GAM600501**  
su ruote  
on castors **GAM600502**



su piedi  
on feet **GAM610500**  
senza piedi  
without feet **GAM610501**  
su ruote  
on castors **GAM610502**

**CONTENITORE AD ANTE SINGOLE**  
cabinet with single doors  
H 91 cm  
H 79 cm **senza piedi** | without feet



su piedi  
on feet **GAM600600**  
senza piedi  
without feet **GAM600601**  
su ruote  
on castors **GAM600602**



su piedi  
on feet **GAM610600**  
senza piedi  
without feet **GAM610601**  
su ruote  
on castors **GAM610602**

**CONTENITORE SPOGLIATOIO AD ANTE SINGOLE**  
locker with single doors  
H 91 cm  
H 79 cm **senza piedi** | without feet



su piedi  
on feet **GAM600700**  
senza piedi  
without feet **GAM600701**  
su ruote  
on castors **GAM600702**



su piedi  
on feet **GAM610700**  
senza piedi  
without feet **GAM610701**  
su ruote  
on castors **GAM610702**

# CONTENITORI

CABINETS

L/W 80 cm	L/W 120 cm
 <p>su piedi on feet <b>GAM601100</b>                      senza piedi without feet <b>GAM601101</b>                      su ruote on castors <b>GAM601102</b></p>	 <p>su piedi on feet <b>GAM611100</b>                      senza piedi without feet <b>GAM611101</b>                      su ruote on castors <b>GAM611102</b></p>
 <p>su piedi on feet <b>GAM601300</b>                      senza piedi without feet <b>GAM601301</b>                      su ruote on castors <b>GAM601302</b></p>	 <p>su piedi on feet <b>GAM611300</b>                      senza piedi without feet <b>GAM611301</b>                      su ruote on castors <b>GAM611302</b></p>
 <p>su piedi on feet <b>GAM601500</b>                      senza piedi without feet <b>GAM601501</b>                      su ruote on castors <b>GAM601502</b></p>	 <p>su piedi on feet <b>GAM611500</b>                      senza piedi without feet <b>GAM611501</b>                      su ruote on castors <b>GAM611502</b></p>
 <p>su piedi on feet <b>GAM601600</b>                      senza piedi without feet <b>GAM601601</b>                      su ruote on castors <b>GAM601602</b></p>	 <p>su piedi on feet <b>GAM611600</b>                      senza piedi without feet <b>GAM611601</b>                      su ruote on castors <b>GAM611602</b></p>
 <p>su piedi on feet <b>GAM601700</b>                      senza piedi without feet <b>GAM601701</b>                      su ruote on castors <b>GAM601702</b></p>	 <p>su piedi on feet <b>GAM611700</b>                      senza piedi without feet <b>GAM611701</b>                      su ruote on castors <b>GAM611702</b></p>

**CONTENITORE A GIORNO**  
 open cabinet  
**H 129 cm**  
**H 117 cm** senza piedi | without feet

**CONTENITORE A CASELLE**  
 open cabinet  
**H 129 cm**  
**H 117 cm** senza piedi | without feet

**CONTENITORE AD ANTE**  
 cabinet with doors  
**H 129 cm**  
**H 117 cm** senza piedi | without feet

**CONTENITORE AD ANTE SINGOLE**  
 cabinet with single doors  
**H 129 cm**  
**H 117 cm** senza piedi | without feet

**CONTENITORE SPOGLIATOIO AD ANTE SINGOLE**  
 locker with single doors  
**H 129 cm**  
**H 117 cm** senza piedi | without feet

**Le ante possono essere dotate di serrature.**  
 Doors can be equipped with locks.



**CONTENITORE A GIORNO**  
 open cabinet  
**H 168 cm**

**CONTENITORE A CASELLE**  
 open cabinet  
**H 168 cm**

**CONTENITORE A GIORNO PASSANTE**  
 open cabinet (half open back)  
**H 168 cm**

**CONTENITORE AD ANTE**  
 cabinet with doors  
**H 168 cm**

**CONTENITORE AD ANTE SINGOLE**  
 cabinet with single doors  
**H 168 cm**

**CONTENITORE SPOGLIATOIO AD ANTE SINGOLE**  
 locker with single doors  
**H 168 cm**

**CONTENITORE SPOGLIATOIO AD ANTE SINGOLE**  
 locker with single doors  
**H 168 cm**

L/W 80 cm	L/W 120 cm
 <p>su piedi on feet <b>GAM602100</b>                      senza piedi without feet <b>GAM602101</b></p>	 <p>su piedi on feet <b>GAM612100</b>                      senza piedi without feet <b>GAM612101</b></p>
 <p>su piedi on feet <b>GAM602300</b>                      senza piedi without feet <b>GAM602301</b></p>	 <p>su piedi on feet <b>GAM612300</b>                      senza piedi without feet <b>GAM612301</b></p>
 <p>su piedi on feet <b>GAM602500</b>                      senza piedi without feet <b>GAM602501</b></p>	 <p>su piedi on feet <b>GAM612500</b>                      senza piedi without feet <b>GAM612501</b></p>
 <p>su piedi on feet <b>GAM602600</b>                      senza piedi without feet <b>GAM602601</b></p>	 <p>su piedi on feet <b>GAM612600</b>                      senza piedi without feet <b>GAM612601</b></p>
 <p>su piedi on feet <b>GAM602700</b>                      senza piedi without feet <b>GAM602701</b></p>	 <p>su piedi on feet <b>GAM612700</b>                      senza piedi without feet <b>GAM612701</b></p>
 <p>su piedi on feet <b>GAM603000</b>                      senza piedi without feet <b>GAM603001</b></p>	 <p>su piedi on feet <b>GAM613000</b>                      senza piedi without feet <b>GAM613001</b></p>

## BASI | BASES

**BASE SU PIEDI**  
 base on feet  
**BASE SU RUOTE**  
 base on castors  
**ZOCCOLO**  
 plinth

45x45xh12 cm	<b>GPN615000</b>	80x45xh12 cm	<b>GPN615001</b>	120x45xh12 cm	<b>GPN615002</b>
45x45xh12 cm	<b>GPN615010</b>	80x45xh12 cm	<b>GPN615011</b>	120x45xh12 cm	<b>GPN615012</b>
45x45xh12 cm	<b>GPN615020</b>	80x45xh12 cm	<b>GPN615021</b>	120x45xh12 cm	<b>GPN615022</b>

# CONTENITORI CURVI

CURVED CABINETS



## CONTENITORI CURVI – ISOLE

curved cabinets – islands

**Contenitori curvilinei definiscono spazi concavi e convessi. Compongono nicchie e isole. Contenitori e sedute morbide coordinate formano ambiti riparati. Piccole stanze che accolgono i bambini per momenti di quiete, racconto, gioco.**



Curved cabinets define concave and convex spaces. They make up niches and islands. Coordinated cabinets and soft seats form cozy areas. Small rooms that welcome children for moments of quiet, storytelling and play.

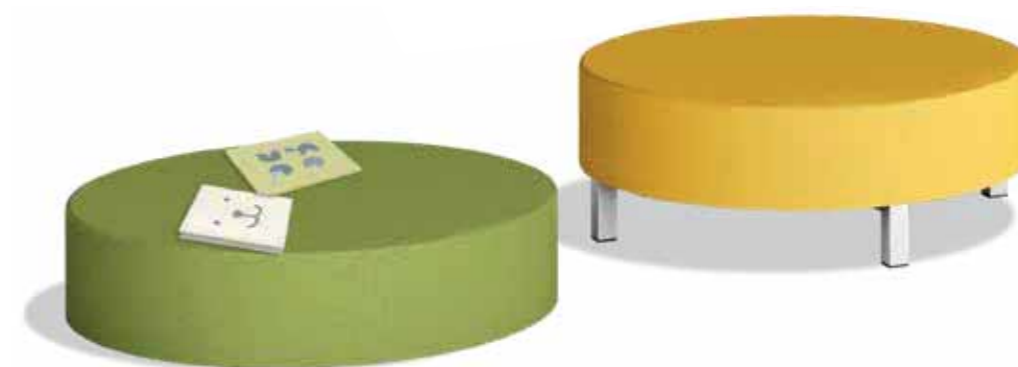

## DIMENSIONI

SIZES

**I contenitori curvilinei sono disponibili in due altezze coordinate con i contenitori lineari.**

Curved cabinets are available in two heights, coordinated with the straight cabinets.

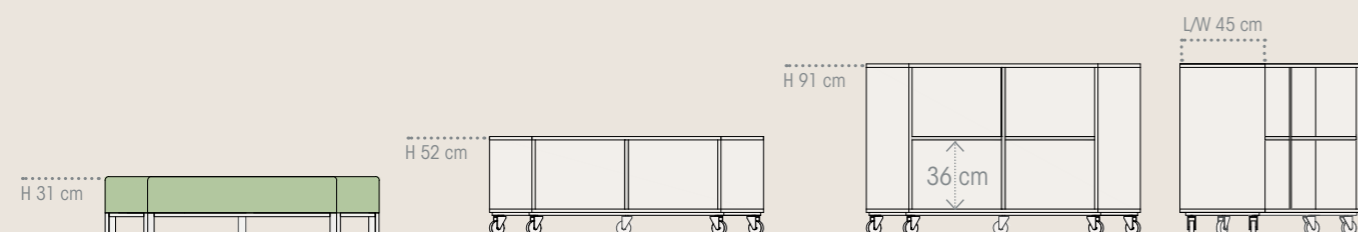

## FINITURE

FINISHES

**Le componenti dei contenitori curvi hanno finiture bianche e betulla uguali a quelle dei contenitori lineari.**

The components of the curved cabinets have milk white and birch finishes identical to those of the straight cabinets.

**cassa**  
structure  
G817

**base metallica**  
metal base  
001F  
RAL 9002

**divisori, ripiani**  
dividers, shelves  
betulla  
birch  
GNBE



**La base dei contenitori è un telaio metallico su piedi o su ruote.**

The base of the cabinets is a metal frame on feet or castors.

# CONTENITORI CURVI

CURVED CABINETS

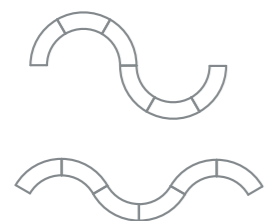

## CONTENITORI CURVI – LINEE

curved cabinets – lines

**Contenitori curvilinei compongono linee sinuose dentro spazi ampi. Linee leggere per separazioni non rigide. I moduli più alti possono essere parzialmente trasparenti per alternare divisione e comunicazione.**

Curved cabinets draw sinuous lines within large spaces. Light lines for non-rigid separations. The taller units can be partially open to alternate division and communication.

## CONTENITORI | CABINETS

### R 100-145 cm

#### CONTENITORE CURVO

curved cabinet  
H 52 cm  
H 40 cm **senza piedi** | without feet

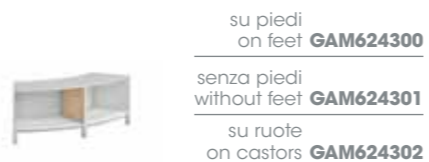
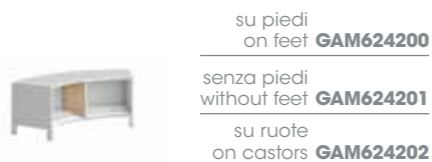

#### CONTENITORE CURVO

curved cabinet  
H 91 cm  
H 79 cm **senza piedi** | without feet

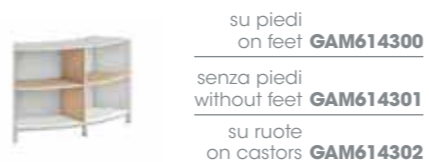
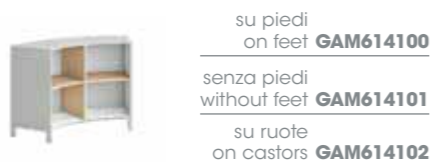

#### CONTENITORE CURVO PASSANTE

open curved cabinet (half open back)  
H 91 cm  
H 79 cm **senza piedi** | without feet

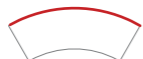
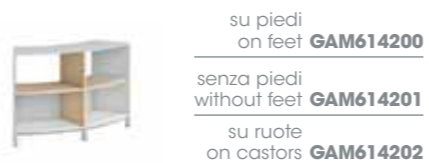
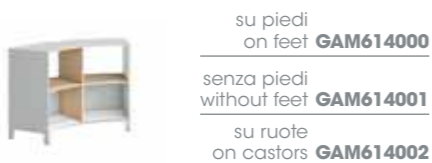

## SEDUTE | SEATS



R55-100x45xh31 cm **GAM616104**  
R65-100x35xh31 cm **GAM616100**



R100-145x45xh31 cm **GAM616101**



R145-190x45xh31 cm **GAM616102**



Ø80xh31 cm **GAM616209**



## BASI | BASES

#### BASE SU PIEDI

base on feet **GPN615003**

#### BASE SU RUOTE

base on castors **GPN615004**

## ACCESSORI | ACCESSORIES



**MINI POUF**  
mini pouf

Ø30xh10 cm **GAI227306**



**TAPPETO TONDO IN MOQUETTE**  
round moquette carpet

Ø200 cm **GA0286205**

# CONTENITORI ACCOGLIENZA

CABINETS  
FOR THE ENTRANCE



## APPENDIABITI coat racks

**Appendiabiti a struttura metallica sono fissati alla base dei contenitori più bassi. Possono essere accostati alle pareti o disposti accoppiati al centro dell'ambiente.**

Coat racks with metal structure are fixed to the base of the lower cabinets. They can be placed next to the walls or arranged in pairs in the center of the room.



## DIMENSIONI

SIZES

**Altezze, larghezze e profondità degli appendiabiti sono coordinate con i contenitori e i pouf, per realizzare composizioni adatte a ogni ambiente.**

Heights, widths, and depths of the coat racks are coordinated with cabinets and poufs, to create compositions suitable for any environment.

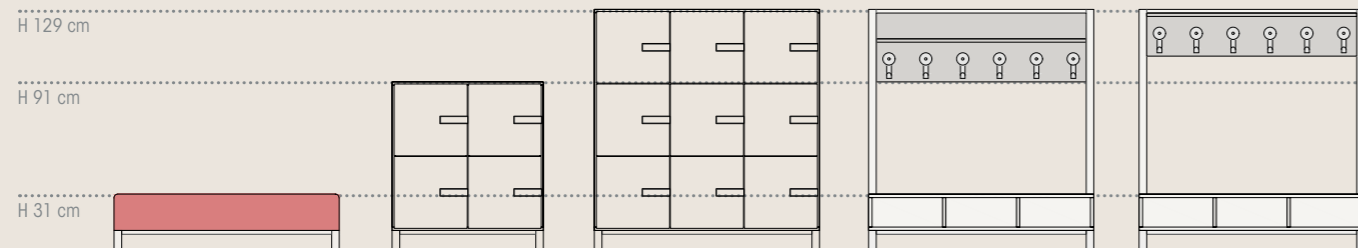

## APPENDIABITI 0-3 coat rack 0-3

80x45xh129 cm **GAM620013**  
120x45xh129 cm **GAM620113**



## APPENDIABITO 3-6 coat rack 3-6

80x45xh129 cm **GAM620003**  
120x45xh129 cm **GAM620103**

## PUNTO E VIRGOLA

PUNTO E VIRGOLA

**Appendino composto da un gancio metallico e un pomello in legno, disponibile in quattro colori.**

Hanger consisting of a metal hook and a wooden knob, available in four colors.

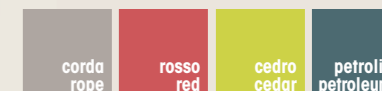

## POUF QUADRATO square pouf

45x45xh31 cm **GAM616200**  
80x80xh31 cm **GAM616201**



## POUF RETTANGOLARE rectangular pouf

80x45xh31 cm **GAM616204**  
120x45xh31 cm **GAM616205**



## POUF TONDO round pouf

Ø80xh31 cm **GAM616209**



## POUF LUNA half-moon pouf

Ø80xh31 cm **GAM616210**

## COMPOSIZIONI

CONFIGURATIONS

**Forme e dimensioni dei pouf consentono di realizzare varie composizioni: lineari, curvilinee, giocose.**

The shapes and sizes of the poufs allow to create many compositions: linear, curvilinear, playful.



**rivestimento parte morbida**  
padding



**base metallica**  
metal base

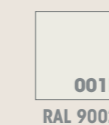



**TAVOLI E SEDIE**  
tables and chairs

**Nuovi tavoli e nuove sedie portano nei servizi per l'infanzia il design e la funzionalità dell'arredo moderno. Geometrie essenziali entrano negli ambienti con leggerezza.**

New tables and chairs bring the design and functionality of modern furniture to schools and childcare centers. Essential geometries give lightness to the environment.

**I tavoli per la scuola dell'infanzia hanno dimensioni coordinate con i contenitori H 52. Si possono comporre postazioni per attività laboratoriali in varie configurazioni.**

The kindergarten tables have dimensions coordinated with the H 52 cabinets. Various layouts for laboratory activities can be composed.

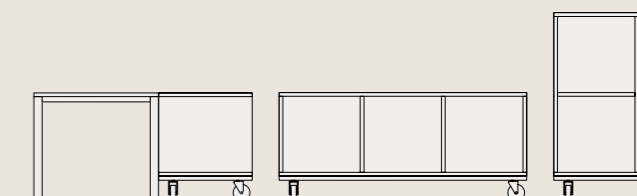



**TAVOLO FILO**  
FILO table

**Tavoli quadrati e rettangolari con piano a filo con le gambe.**

Square and rectangular tables with top flush to the legs.



**TAVOLO STONDO**  
STONDO table

**Tavoli quadrati e rettangolari con piano con angoli stondati e gambe rientrate.**

Square and rectangular tables with top with rounded corners and recessed legs.



**DIMENSIONI**

SIZES

**I tavoli sono disponibili in cinque altezze. La più bassa è adatta ai bambini del nido, la più alta agli adulti.**

The tables are available in five heights. The lowest is for infant and toddlers, the highest is for adults.

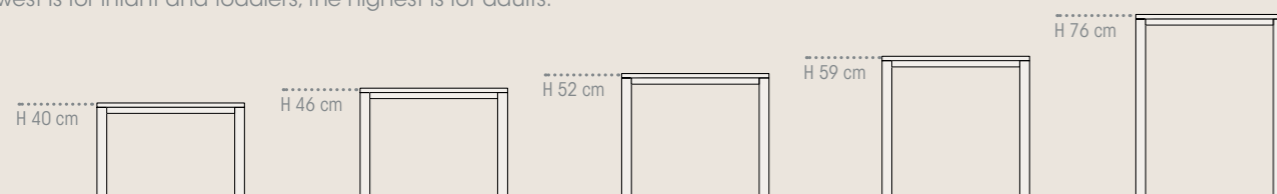

**I tavoli alti 40 centimetri sono adatti ai bambini del nido e possono essere utilizzati con sedie pluriuso.**

The 40cm high tables are suitable for infant and toddlers and can be used with multi-purpose chairs.

**MATERIALI E COLORI**

MATERIALS AND COLORS

**I piani dei tavoli sono in nobilitato betulla o bianco latte. Le gambe sono in metallo bianco latte.**

The tabletops are in birch or white milk melamine chipboard. The legs are in milk white metal.

piano  
tabletop

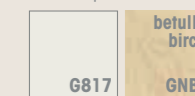

gambe  
legs

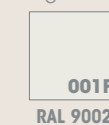



**MATITA**  
MATITA

**MATITA è la nuova sedia GAM in multistrato di betulla. È leggera e impilabile. Il design semplice e lineare richiama l'essenzialità dei disegni dei bambini.**

MATITA is the new GAM chair made of birch plywood. It is lightweight and stackable. The simple and linear design recalls the essentiality of children's drawings.



**G-TYPE**  
G-TYPE

**G-TYPE è la sedia monoscocca ideata da GAM e prodotta in collaborazione con la capogruppo iMilani. È un progetto originale, sviluppato con il contributo di competenze specialistiche, per trovare la miglior sintesi di estetica, funzionalità, ergonomia e qualità produttiva.**

G-TYPE is the monocoque chair designed by GAM and produced in collaboration with the parent company iMilani. This is an original design, developed through specialized skills to find the best synthesis of aesthetics, functionality, ergonomics, and production quality.



**DIMENSIONI**

SIZES

**Le sedie sono disponibili in tutte le misure previste dalla norma EN 1729.**

Chairs are available in all sizes required by the EN 1729 standard.

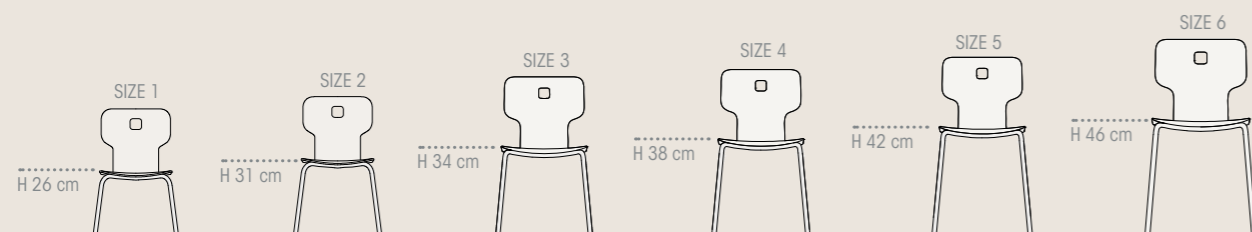

**MATERIALI E COLORI**

MATERIALS AND COLORS

**G-TYPE è disponibile con scocca in plastica in cinque colori. La versione grigio antracite può essere realizzata in PP ignifugo CL1 e PP riciclato (ReMade in Italy). È disponibile anche in compensato curvato.**

G-TYPE is available with plastic shell in five colors. The anthracite version can be made of CL1 fireproof PP and recycled PP (ReMade in Italy). Is also available in curved natural plywood.

**scocca in legno**  
wooden shell

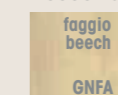

**scocca plastica**  
plastic shell



**struttura metallica**  
metal frame

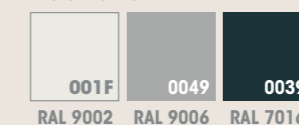

**\* disponibile anche nella versione con scocca in plastica riciclata e con scocca ignifuga CL1**  
also available with recycled plastic shell and with CL1 fireproof shell



# TAVOLI E SEDIE

TABLES AND CHAIRS



**TAVOLO FILO QUADRATO**  
square FILO table

60x60xh40 cm  
60x60xh46 cm  
60x60xh52 cm  
60x60xh59 cm  
60x60xh76 cm

**GAM900100**  
**GAM900101**  
**GAM900102**  
**GAM900103**  
**GAM900106**

80x80xh40 cm  
80x80xh46 cm  
80x80xh52 cm  
80x80xh59 cm  
80x80xh76 cm

**GAM900200**  
**GAM900201**  
**GAM900202**  
**GAM900203**  
**GAM900206**

120x120xh40 cm  
120x120xh46 cm  
120x120xh52 cm  
120x120xh59 cm  
120x120xh76 cm

**GAM900300**  
**GAM900301**  
**GAM900302**  
**GAM900303**  
**GAM900306**



**TAVOLO FILO RETTANGOLARE**  
rectangular FILO table

120x60xh40 cm  
120x60xh46 cm  
120x60xh52 cm  
120x60xh59 cm  
120x60xh76 cm

**GAM900600**  
**GAM900601**  
**GAM900602**  
**GAM900603**  
**GAM900606**

120x80xh40 cm  
120x80xh46 cm  
120x80xh52 cm  
120x80xh59 cm  
120x80xh76 cm

**GAM901000**  
**GAM901001**  
**GAM901002**  
**GAM901003**  
**GAM901006**

160x80xh40 cm  
160x80xh46 cm  
160x80xh52 cm  
160x80xh59 cm  
160x80xh76 cm

**GAM901200**  
**GAM901201**  
**GAM901202**  
**GAM901203**  
**GAM901206**



**TAVOLO STONDO QUADRATO**  
square STONDO table

68x68xh40 cm  
68x68xh46 cm  
68x68xh52 cm  
68x68xh59 cm  
68x68xh76 cm

**GAM500100**  
**GAM500101**  
**GAM500102**  
**GAM500103**  
**GAM500106**

88x88xh40 cm  
88x88xh46 cm  
88x88xh52 cm  
88x88xh59 cm  
88x88xh76 cm

**GAM500200**  
**GAM500201**  
**GAM500202**  
**GAM500203**  
**GAM500206**

128x128xh40 cm  
128x128xh46 cm  
128x128xh52 cm  
128x128xh59 cm  
128x128xh76 cm

**GAM500300**  
**GAM500301**  
**GAM500302**  
**GAM500303**  
**GAM500306**



**TAVOLO STONDO RETTANGOLARE**  
rectangular STONDO table

128x68xh40 cm  
128x68xh46 cm  
128x68xh52 cm  
128x68xh59 cm  
128x68xh76 cm

**GAM500600**  
**GAM500601**  
**GAM500602**  
**GAM500603**  
**GAM500606**

128x88xh40 cm  
128x88xh46 cm  
128x88xh52 cm  
128x88xh59 cm  
128x88xh76 cm

**GAM501000**  
**GAM501001**  
**GAM501002**  
**GAM501003**  
**GAM501006**

168x88xh40 cm  
168x88xh46 cm  
168x88xh52 cm  
168x88xh59 cm  
168x88xh76 cm

**GAM501200**  
**GAM501201**  
**GAM501202**  
**GAM501203**  
**GAM501206**



**TAVOLO TONDO**  
TONDO table

Ø92xh40 cm  
Ø92xh46 cm  
Ø92xh52 cm  
Ø92xh59 cm  
Ø92xh76 cm

**GAM901600**  
**GAM901601**  
**GAM901602**  
**GAM901603**  
**GAM901606**

Ø121xh40 cm  
Ø121xh46 cm  
Ø121xh52 cm  
Ø121xh59 cm  
Ø121xh76 cm

**GAM901800**  
**GAM901801**  
**GAM901802**  
**GAM901803**  
**GAM901806**



**MATITA**  
MATITA

30x33xh26/48,5 cm  
33x37xh31/56 cm  
36x40xh34/61 cm

**GA0244401**  
**GA0244402**  
**GA0244403**



**G-TYPE SCOCCA IN LEGNO, SU GAMBE**

G-TYPE chair — wooden shell, on legs

h26 cm  
h31 cm  
h34 cm  
h38 cm  
h42 cm  
h46 cm

**GPN907401**  
**GPN907402**  
**GPN907403**  
**GPN907404**  
**GPN907405**  
**GPN907406**



**G-TYPE SCOCCA IN PLASTICA, SU GAMBE**

G-TYPE chair — plastic shell, on legs

h26 cm  
h31 cm  
h34 cm  
h38 cm  
h42 cm  
h46 cm

**GPN907301**  
**GPN907302**  
**GPN907303**  
**GPN907304**  
**GPN907305**  
**GPN907306**



**G-TYPE SCOCCA IN LEGNO, SU RUOTE**

G-TYPE chair — wooden shell, on castors

h38/46 cm  
h42/50 cm

**GPN907700**  
**GPN907702**



**G-TYPE SCOCCA IN PLASTICA, SU RUOTE**

G-TYPE chair — plastic shell, on castors

h38/46 cm  
h42/50 cm

**GPN907600**  
**GPN907602**





**ARREDI LAB**  
lab furnishings

**Tavoli speciali, alti e bassi, e pannelli da appendere a parete, ampliano il sistema di arredi GAM per allestire laboratori e atelier.**

Special tables and wall panels expand the GAM furnishing system for setting up laboratories and ateliers.



**DIMENSIONI**  
SIZES

**Gli arredi LAB hanno dimensioni coordinate tra loro e con il sistema dei contenitori.**

The sizes of LAB furnishings are coordinated with each other and with the cabinet system.





**TAVOLO COSTRUZIONI**  
construction table

**Tavolo con contenitori per pezzi per costruzioni e materiali vari. Disponibile in due altezze, da usare stando in piedi o seduti per terra.**

Table with compartments for constructions and various materials. Available in two heights, to be used while standing or sitting on the floor.



**TAVOLO MATTONCINI**  
building bricks table

**Tavolo per costruzioni dedicato ai mattoncini LEGO® DUBLO®. Sul piano è fissata la piastra base delle costruzioni.**

Construction table dedicated to LEGO® DUBLO® bricks. The building baseplate is fixed on the tabletop.

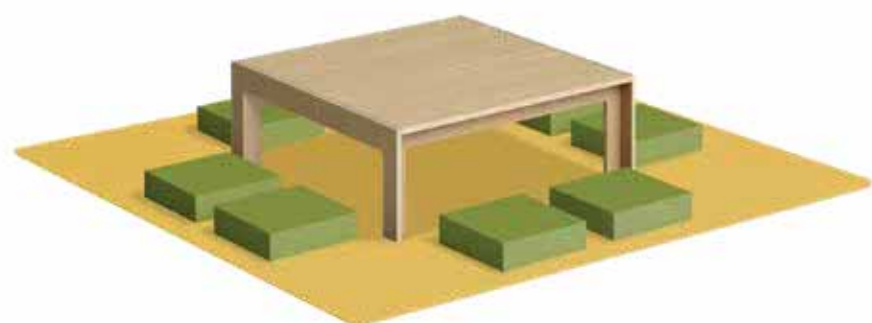

**TAVOLO GIAPPONESE**  
Japanese table

**Tavolo da usare stando seduti per terra o su cuscini bassi.**

Table to be used while sitting on the floor or on low cushions.



**BANCO GREEN**  
green table

90x90xh55/102.5 cm **GA0241524**



**BANCO MANIPOLAZIONE**  
manipulative table

90x90xh55 cm **GA0241531**



**TAVOLO SPECCHIO**  
mirror table

75x75xh55 cm **GA0241532**



**TAVOLO GIAPPONESE**  
Japanese table

90x90xh28.5cm **GA0241536**



**TAVOLO CODING**  
coding table

90x90xh23 cm **GA0241535**  
90x90xh55 cm **GA0241534**



**TAVOLO COSTRUZIONI**  
construction table

90x90xh23 cm **GA0241538**  
90x90xh55 cm **GA0241537**



**TAVOLO MATTONCINI**  
building bricks table

90x90xh23 cm **GA0241540**  
90x90xh55 cm **GA0241539**



**PANNELLO DISEGNO**  
drawing panel

80x25xh80 cm **GA0400200**  
120x25xh80 cm **GA0400201**



**PANNELLO LAVAGNA**  
blackboard panel

80x25xh80 cm **GA0400300**  
120x25xh80 cm **GA0400301**



**PANNELLO BIANCO**  
whiteboard panel

80x25xh80 cm **GA0400400**  
120x25xh80 cm **GA0400401**



**MENSOLA**  
shelf

80x25xh15 cm **GA0400000**  
120x25xh15 cm **GA0400001**



**MENSOLA CON FORI**  
perforated shelf

80x25xh15 cm **GA0400100**  
120x25xh15 cm **GA0400101**

**I pannelli e le mensole hanno dimensioni coordinate con contenitori e pedane.**

The sizes of panels and shelves are coordinated with cabinets and platforms.

# GREEN FRAME

GREEN FRAME



**COMPOSIZIONE GREEN**  
green configuration

**GREEN FRAME**  
GREEN FRAME

Sistema di telai spaziali studiato per dare spazio a piante in vaso nei servizi per l'infanzia. La struttura in alluminio e gli accessori in legno consentono infinite composizioni.

Frame system, designed to house potted plants in children's environments. The aluminum frame and wooden accessories allow endless and multipurpose compositions.

## COMPONENTI

COMPONENTS

I telai GREEN FRAME sono composti da pochi semplici elementi: barre di tubolare quadro in alluminio di un'unica lunghezza e nodi in plastica di quattro tipi.

GREEN FRAME is made of a few, simple elements: square tubular aluminum bars in a single length and four types of plastic connectors.

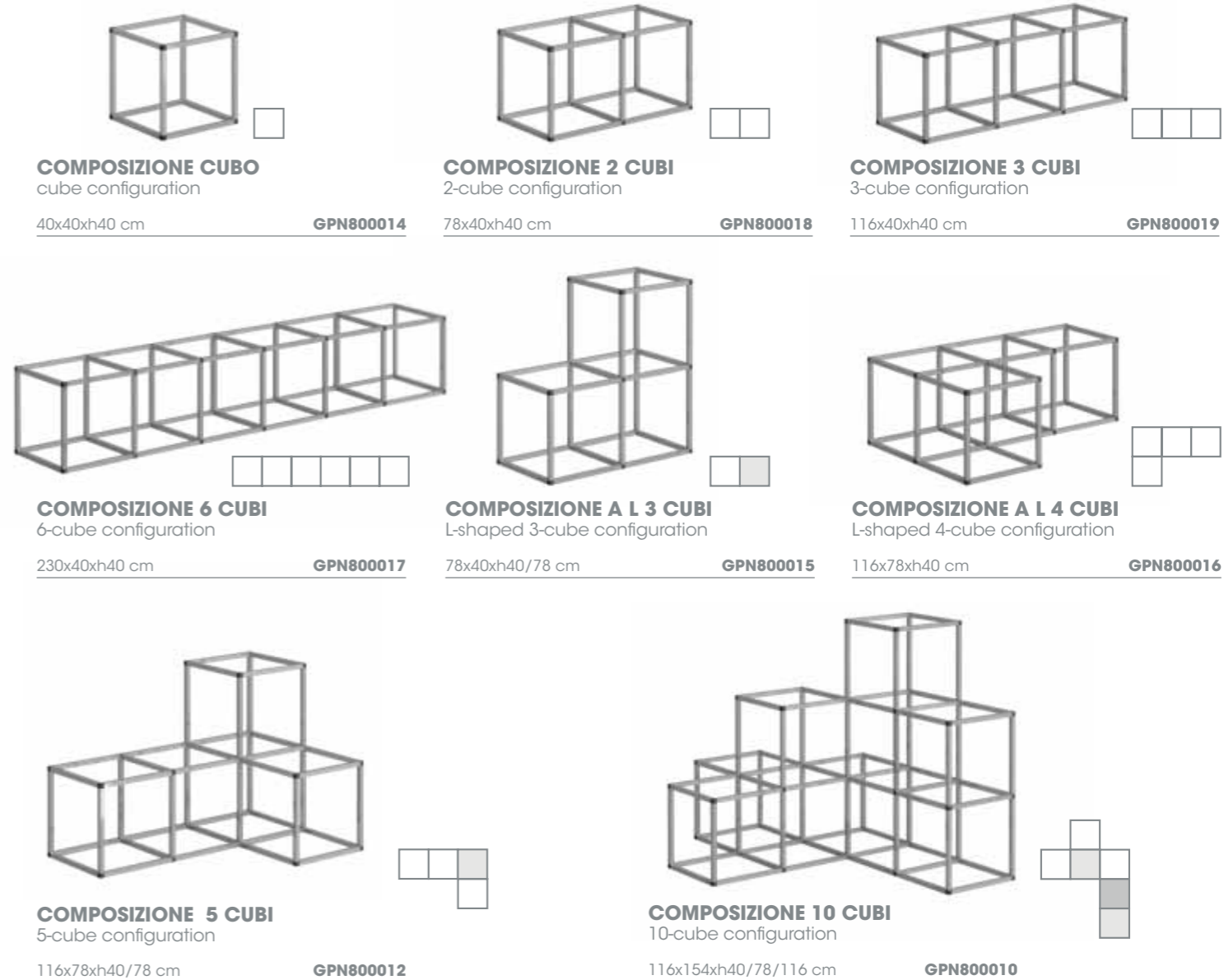
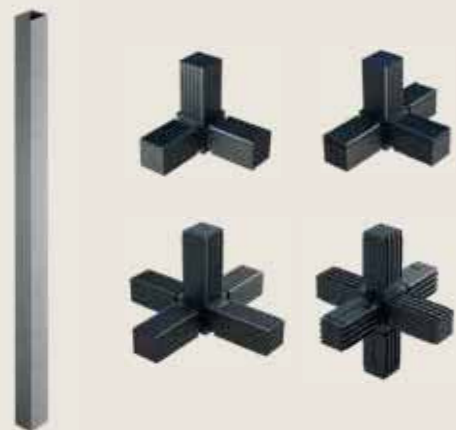

# GREEN FRAME

GREEN FRAME



**COMPOSIZIONE LAB**  
lab configuration

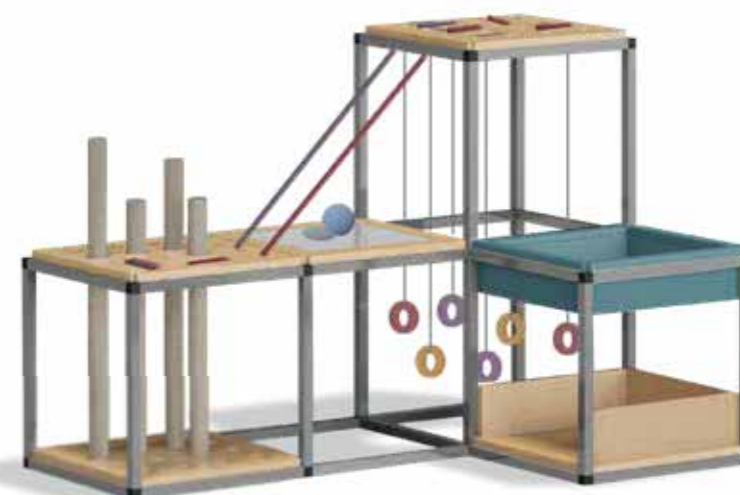

**COMPOSIZIONE GIOCO**  
play configuration



**COMPOSIZIONE BIBLIO**  
book configuration



**Accessori speciali consentono di realizzare composizioni per le attività dei bambini. Sono oggetti leggeri e innovativi, insoliti negli spazi dedicati all'infanzia.**

Special accessories allow to create compositions for children's activities. They are light and innovative. Unusual in children's environments.



**COMPOSIZIONE GIOCO SIMBOLICO**  
play role configuration



## MATERIALI E COLORI

MATERIALS AND COLORS

**Tutti gli accessori sono in multistrato di betulla naturale. Il piano e il contenitore aperto sono disponibili anche in tre colori coordinati con il rivestimento del pouf.**

All accessories are in natural birch plywood. The top and the tray are also available in three colors coordinated with the pouf covering.

**piano, contenitore**  
shelf, tray



**altri accessori**  
other accessories

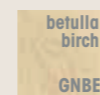

**pouf**  
pouf



**PIANO PORTALIBRI**  
bookshelf

38x38x13 cm **GPN800035**



**CONTENITORE PORTALIBRI**  
bookcase

38x38x13 cm **GPN800036**



**PIANO CON SPECCHIO**  
mirror top

38x38 cm **GPN800045**



**PIANO CON FORI**  
perforated top

38x38 cm **GPN800039**



**CONTENITORE CON COPERCHIO**  
tray with lid

38x38x10 cm **GPN800046**



**CONTENITORE A GIORNO**  
open cabinet

38x38x27 cm **GPN800040**



**PIANO CUCINA**  
kitchen top

38x38x10 cm **GPN800041**



**PIANO LAVANDINO**  
sink top

38x38x10 cm **GPN800042**

# INSIDE OUT

INSIDE OUT

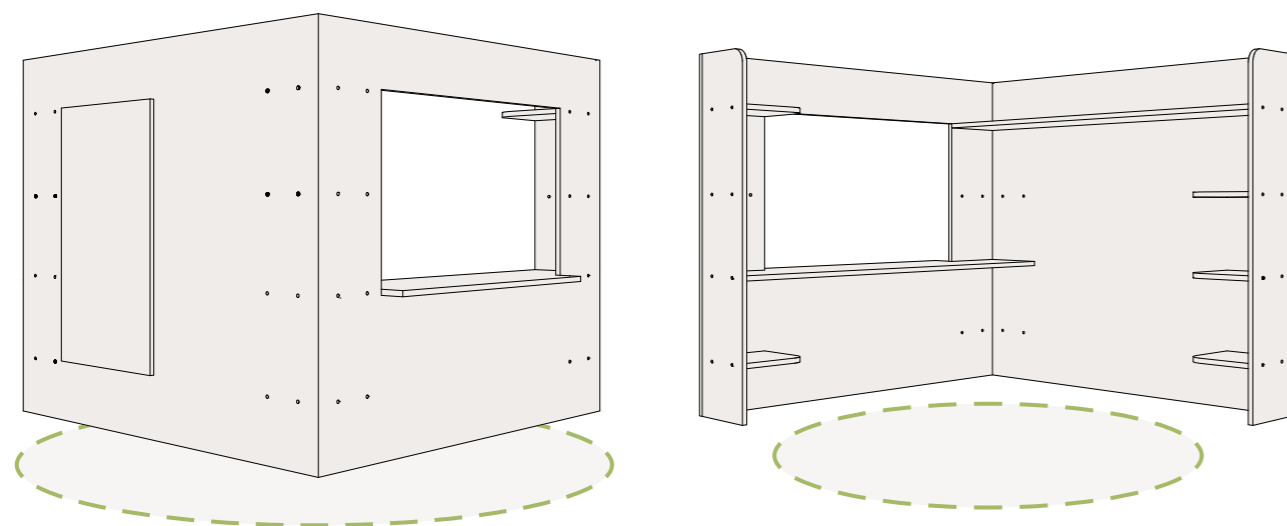

## INSIDE OUT

**INSIDE OUT è una serie di volumi aperti multifunzionali che modificano lo spazio in cui sono inseriti. Un angolo di pareti di legno forma un piccolo ambito. Si definisce un interno e un esterno. Un'apertura tra dentro e fuori provoca relazioni. INSIDE OUT offre allestimenti per situazioni diverse.**

INSIDE OUT is a series of multifunctional open volumes changing the space in which they're inserted. A corner of wooden walls creates a small area. It defines an interior and an exterior. The opening between the inside and the outside promotes relationships. INSIDE OUT offers setups for different situations.

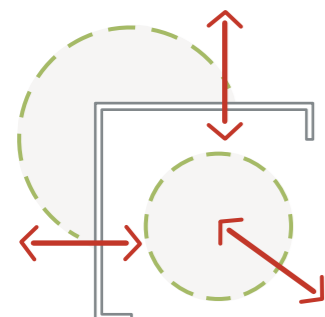

## INSIDE OUT TRAVESTIMENTI

INSIDE OUT disguises

**Microspazio attrezzato come il camerino di un teatro. All'interno, c'è un guardaroba con toletta. All'esterno, uno specchio grande e una lavagna bianca per disegnare nuovi vestiti.**

Microspace equipped like a theater dressing room. Inside, there is a cloakroom with dressing table. Outside, there is a large mirror and a whiteboard to draw new clothes.



## INSIDE OUT TRAVESTIMENTI

INSIDE OUT disguises

150x150xh129 cm **GAM264020**

Il pouf non è compreso  
Pouf not included

## SPAZI

SPACES

**Composizioni di INSIDE OUT formano spazi di varie forme e dimensioni. Da microspazi raccolti ad ambienti più grandi, fino a sequenze che articolano locali molto ampi.**

INSIDE OUT compositions form spaces of various shapes and sizes. From micro to larger environments, up to wall sequences that articulate very large rooms.

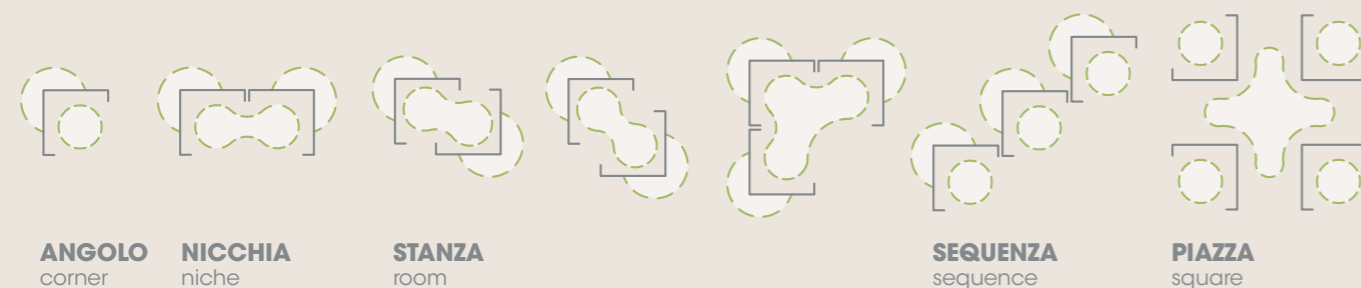

## DIMENSIONI

DIMENSIONS

**Le dimensioni di INSIDE OUT sono calibrate in relazione agli altri arredi GAM. L'altezza supera i QUIOLA' ed è coordinata con CASAMIA e i contenitori a tre comparti.**

The sizes of INSIDE OUT are calibrated to other GAM furnishings. The height exceeds QUIOLA' items and is coordinated with CASAMIA and 3-compartment cabinets.

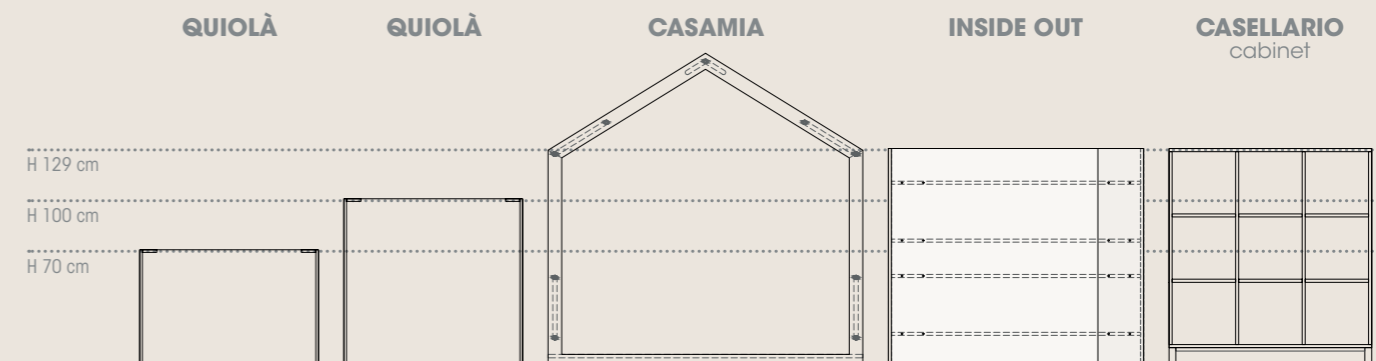

# INSIDE OUT

INSIDE OUT

## INSIDE OUT TEATRO

INSIDE OUT theatre

**Teatrino per spettacoli di piazza.**  
**All'interno ci sono appendini e vani per marionette e scenografie.**  
**All'esterno, il boccascena e una lavagna per disegnare il manifesto dello spettacolo.**

Theater for street performances.  
 Inside, there are hangers and storage compartments for puppets and sets. Outside, there is the proscenium and a whiteboard to draw the show's poster.



## INSIDE OUT TEATRO

INSIDE OUT theatre

150x150xh129 cm **GAM264021**

## INSIDE OUT BIBLIOTECA

INSIDE OUT library

**Piccola libreria e angolo lettura.**  
**L'interno è uno spazio riparato, tra scaffali e mensole.**  
**Fuori sono esposti altri libri.**

Small library and reading corner.  
 The interior is a sheltered space, among bookshelves and displays. Other books can be displayed outside.



## INSIDE OUT BIBLIOTECA

INSIDE OUT library

150x150xh129 cm **GAM264022**

I pouf non sono compresi  
 Poufs not included

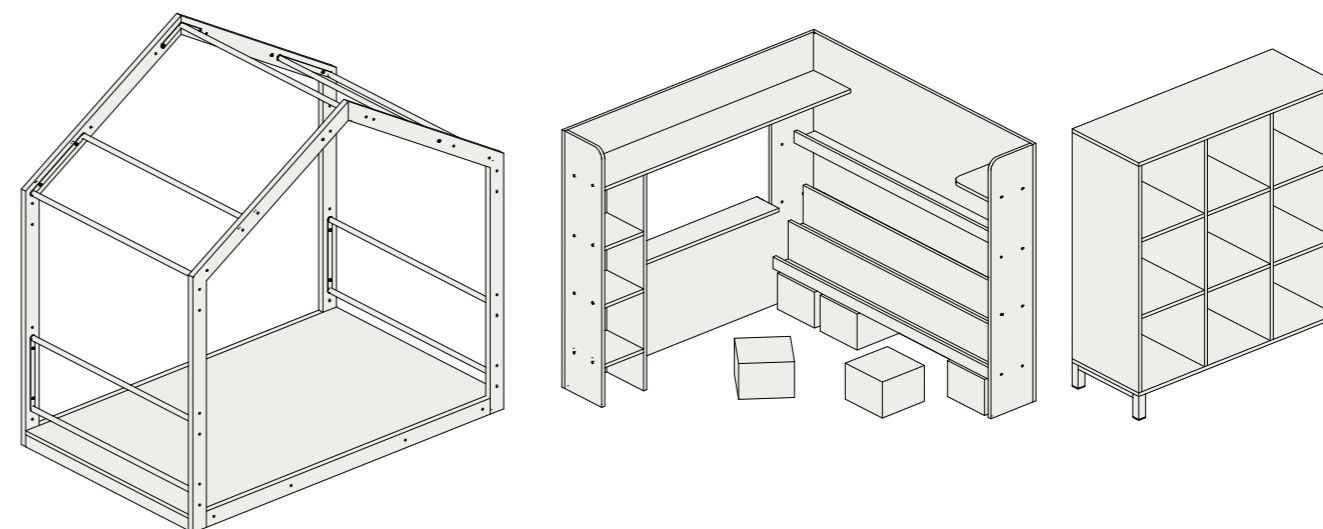
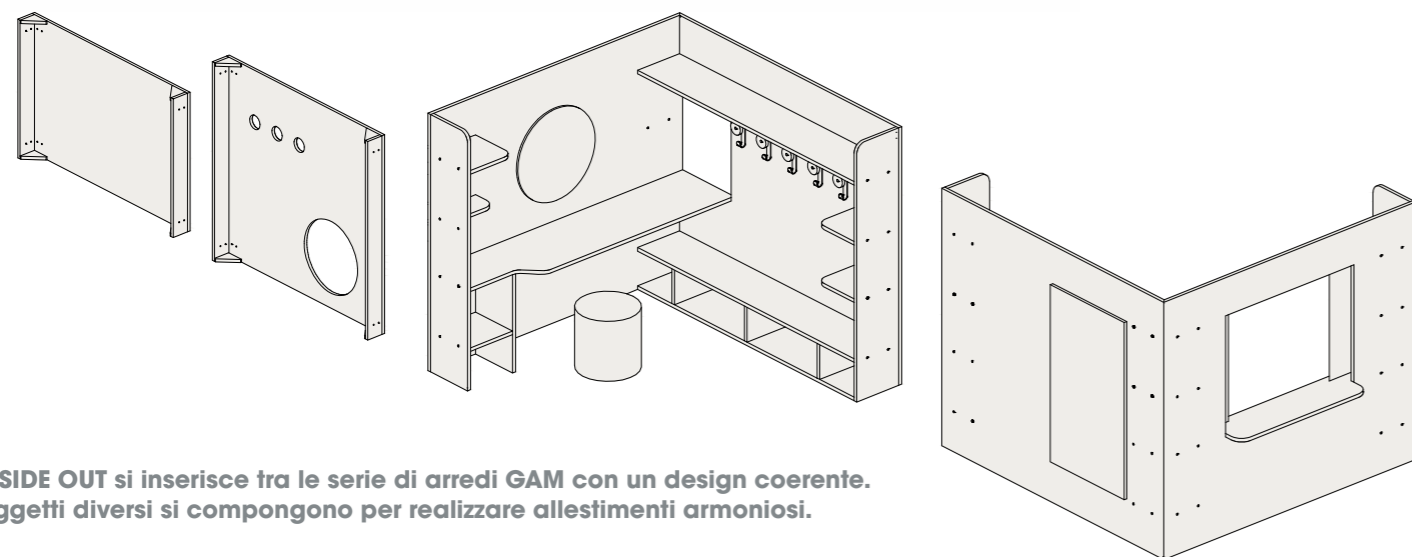

**INSIDE OUT si inserisce tra le serie di arredi GAM con un design coerente.**  
**Oggetti diversi si compongono per realizzare allestimenti armoniosi.**

INSIDE OUT fits into the GAM furnishings with a coherent design.  
 Different elements are combined to create harmonious environments.

# PEDANE E PANNELLI

PLATFORMS AND PANELS



## PEDANE E PANNELLI

platforms and panels

**Pedane e pannelli rispondono ai desideri e alle esigenze dei bambini. Le pedane rendono il pavimento abitabile. I pannelli permettono di usare le pareti come superfici per attività e gioco. Il sistema trasforma lo spazio dei servizi per l'infanzia.**

Platforms and panels respond to children's wishes and needs. The platforms make the floor livable. The panels allow to use the walls as activity and play surfaces. The system redefines the space of children's environments.

## DIMENSIONI E MATERIALI

SIZES AND MATERIALS

**Le pedane hanno piano e due fianchi in nobilitato betulla, due fianchi in nobilitato bianco latte. Sono disponibili in quattro altezze, per composizioni a scalare.**

The platforms are made with top and two sides in birch melamine, two sides in milk white melamine. They are available in four heights to build stepped compositions.



betulla  
birch  
GNBE 6817



## COMPOSIZIONI

CONFIGURATIONS

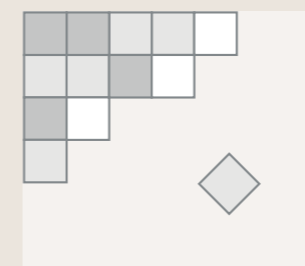

**ANGOLI**  
corners

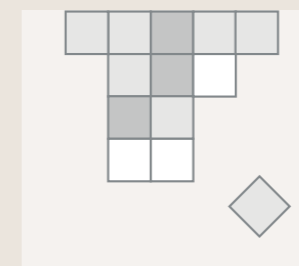

**PENISOLE**  
peninsulas

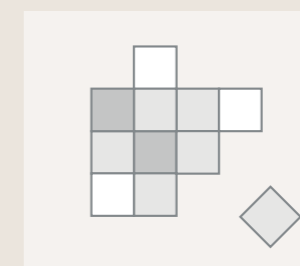

**ISOLE**  
islands

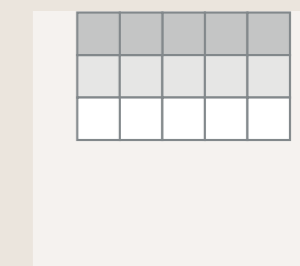

**TRIBUNE**  
tiered seatings



# PEDANE E PANNELLI

PLATFORMS AND PANELS



**PANNELLO LEGNO**  
wooden panel

80x80 cm **GP0909428**



**PANNELLO SUGHERO**  
cork panel

80x80 cm **GP0909440**



**PANNELLO LAVAGNA BIANCA**  
whiteboard panel

80x80 cm **GP0909442**



**PANNELLO LAVAGNA**  
blackboard panel

80x80 cm **GP0909444**



**PANNELLO SPECCHIO**  
mirror panel

80x80 cm **GP0909446**



**PANNELLO PORTALIBRI**  
book display panel

80x8x80 cm **GP0909436**



**PANNELLO ESPOSITORE**  
display panel

80x19x80 cm **GP0909430**



**PANNELLO CASELLARIO**  
pannello casellario

80x19x80 cm **GP0909450**



**PANNELLO MENSOLE**  
shelf panel

80x12x80 cm **GP0909454**



**PANNELLO PORTAROTOLO**  
roll holder panel

80x80 cm **GP0909448**



**PANNELLO PERNI**  
knobs panel

80x80 cm **GP0909456**



**PANNELLO AUTOCOSTRUZIONE SENSORIALE**  
DIY sensorial panel

80x6x80 cm **GP0909458**



**PANNELLO SCATOLE**  
box panel

80x19/27x80 cm **GP0909452**



**PEDANA QUADRATA**  
square platform

80x80x9,5 cm **GP0909310**  
80x80x19 cm **GP0909210**  
80x80x28,5 cm **GP0909311**  
80x80x38 cm **GP0909211**



**PEDANA RETTANGOLARE**  
rectangular platform

160x80x9,5 cm **GP0909312**  
160x80x19 cm **GP0909220**  
160x80x28,5 cm **GP0909313**



**PEDANA CONTENITORE**  
storage box platform

80x80x19 cm **GP0909225**  
80x80x38 cm **GP0909226**



**PEDANA CON PIANO SCRIVIBILE**  
platform with writable top

80x80x19 cm **GP0909314**  
80x80x38 cm **GP0909315**



**PEDANA CON SPECCHIO**  
mirror platform

80x80x19 cm **GP0909316**  
80x80x38 cm **GP0909317**



**PEDANA PORTAVASI**  
potholder platform

80x80x19 cm **GP0909235**  
80x40x57 cm **GP0909229**



**PEDANA CON CASSETTI**  
platform with drawers

80x80x38 cm **GP0909319**



**PEDANA SU RUOTE**  
platforms on castors

80x80x19 cm **GP0909213**

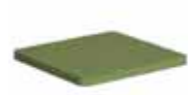

**CUSCINO**  
cushion

40x40x3 cm **GP0909230**  
40x80x3 cm **GP0909231**  
80x80x3 cm **GP0909232**

**PANNELLO AUTOCOSTRUZIONE SENSORIALE**  
DIY SENSORIAL PANEL

**Pannello per realizzare superfici sensoriali. Base con guide che supportano riquadri in legno. Quattro riquadri sono forniti semplici, senza materiali sensoriali.**

Panel for creating sensory surface. Equipped with guides for inserting wooden squares. Four squares are provided plain, without sensory materials.

**PANNELLO SCATOLE**  
BOX PANEL

**Il PANNELLO SCATOLE può essere fissato alla parete in quattro posizioni. Un unico oggetto permette di realizzare molte composizioni diverse.**

The BOX PANEL can be fixed to the wall in four positions. A single item allows to create many different compositions.



**SENZ'ANGOLI**  
SENZ'ANGOLI

**SENZ'ANGOLI è una serie di pedane con piano curvilineo: tondo, ellittico, a forma di otto.**  
**Sono isole che diventano poli al centro delle stanze, per incontrarsi, trattenersi, giocare.**  
**Un disco giallo copre un vano aperto sul top. Cassetti su ruote e pouf si inseriscono tra i pannelli della base.**

SENZ'ANGOLI is a series of curvilinear platforms: round, elliptical, eight-shaped. They create islands that become central points for meeting, spending time and playing. A yellow disc covers the open compartment on top. Drawers on wheels and poufs fit between the base panels.

**GEOMETRIA RASSICURANTE**  
COMFORTING GEOMETRY

**Le pedane SENZ'ANGOLI sono oggetti rassicuranti. Tengono insieme geometria cartesiana e linee morbide.**  
**Il piano curvilineo è fissato a una griglia di pannelli a incastro.**

SENZ'ANGOLI platforms are comforting items. They follow Cartesian geometry and smooth lines. The curvilinear top is fixed to a grid of interlocking panels.

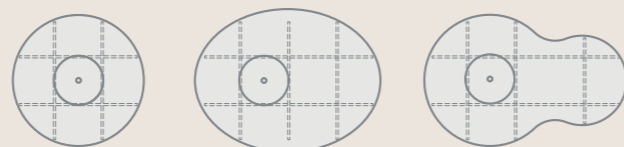

**SENZ'ANGOLI TONDO**  
round SENZ'ANGOLI

Ø110xh28,5 cm

**GAM909020**



**SENZ'ANGOLI ELLISSE**  
ellipse SENZ'ANGOLI

156x120xh28,5 cm

**GAM909021**



**SENZ'ANGOLI OTTO**  
eight-shaped SENZ'ANGOLI

170x75/110xh28,5 cm

**GAM909022**



**CASSETTO SU RUOTE**  
drawer on castors

36x28xh23 cm

**GAM909023**



**POUF TONDO**  
Round pouf

Ø30xh10 cm  
Ø50xh29 cm

**GAI227306**  
**GAI227307**



**TAPPETO TONDO IN MOQUETTE**  
round moquette carpet

Ø200 cm  
Ø250 cm  
Ø300 cm

**GA0286205**  
**GA0286247**  
**GP0286313**

**SKUBI**  
SKUBI

**Due serie di blocchi morbidi di varie geometrie, per comporre percorsi e palestrine. Due blocchi fanno un cubo. I cubi si impilano in grandi riquadri.**

Two series of soft blocks of various shapes to compose paths and gyms. Two blocks make a cube. The cubes stack into large squares.

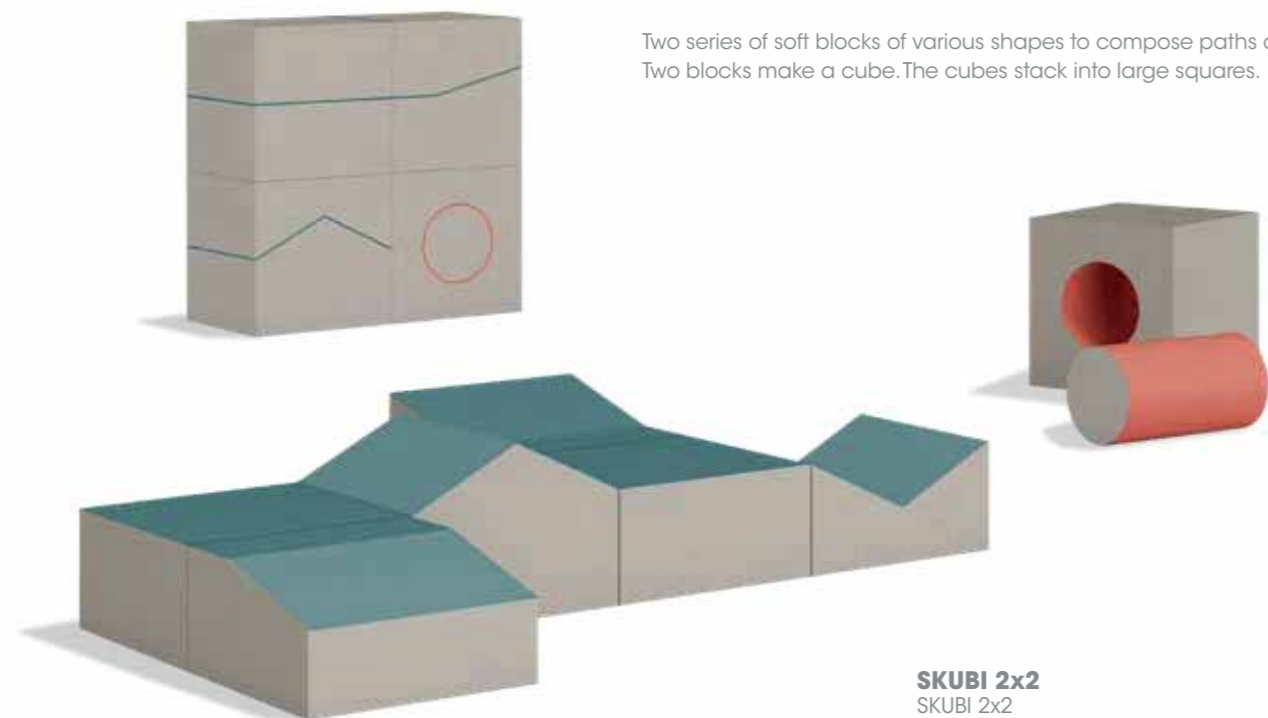

**SKUBI 2x2**  
SKUBI 2x2

combinazione 01 | combination 01  
120x60xh120 cm  
combinazione 02 | combination 02  
120x60xh120 cm

**GAI216600**

**GAI216601**

**SKUBI 2x2**  
SKUBI 2x2

**4 cubi, 8 blocchi. Per comporre un percorso di quasi 5 metri di lunghezza.**

4 cubes, 8 blocks. To compose a path almost 5 meters long.

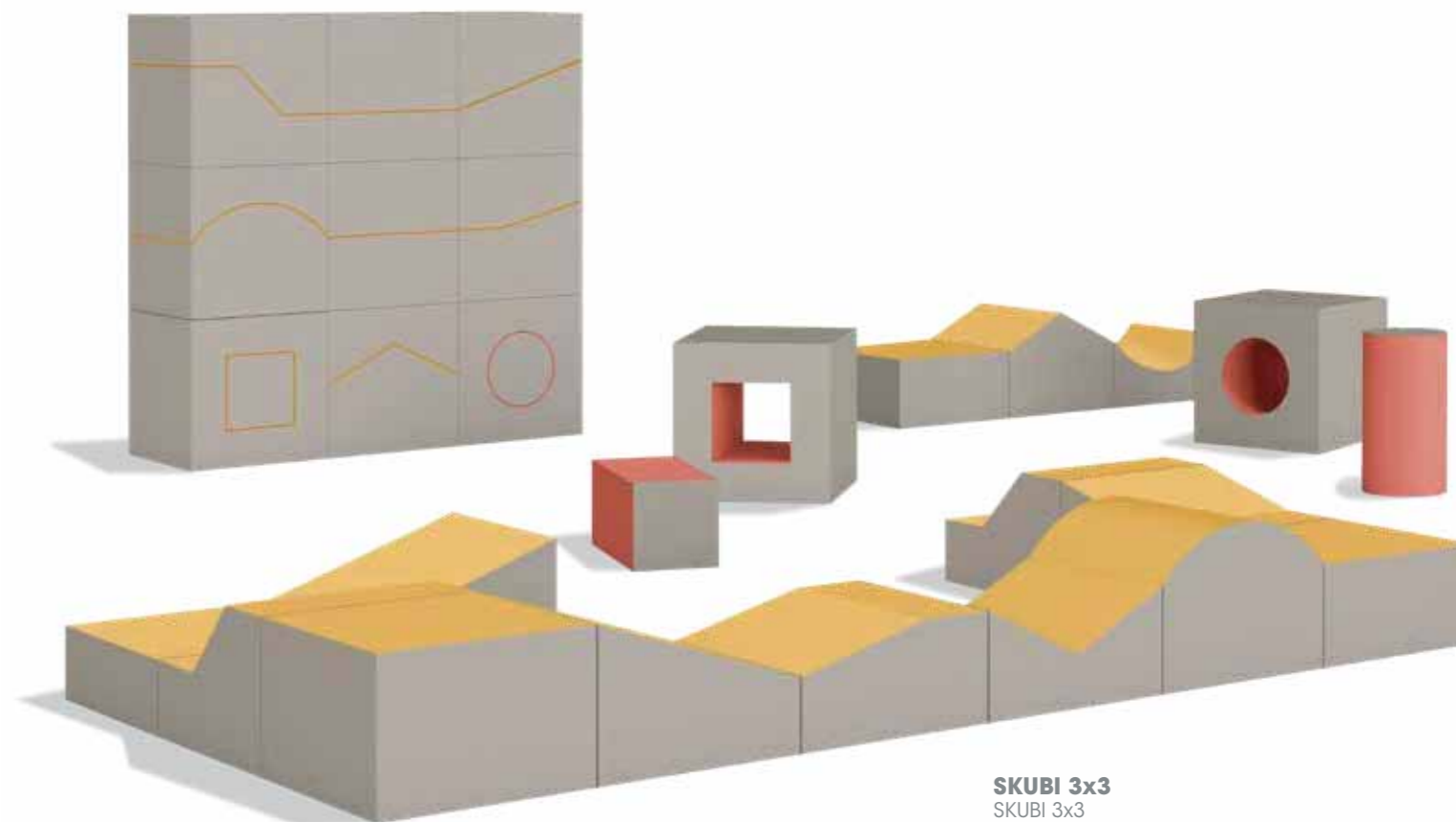

**SKUBI 3x3**  
SKUBI 3x3

combinazione 01 | combination 01  
180x60xh180 cm  
combinazione 02 | combination 02  
180x60xh180 cm

**GAI216602**

**GAI216603**

**SKUBI 3x3**  
SKUBI 3x3

**9 cubi, 18 blocchi. Per comporre un percorso lungo più di 10 metri.**

9 cubes, 18 blocks. To compose a path longer than 10 meters.

**COMPONIBILITA'**  
MODULARITY

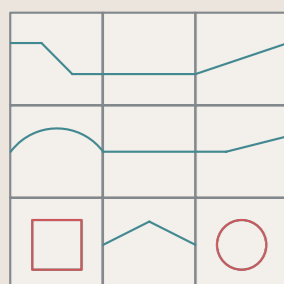

**La caratteristica speciale di SKUBI è la componibilità dei pezzi in una serie di cubi, tutti "tagliati" in modi diversi. Ricomporre i cubi e metterli in ordine è un gioco per i bambini. I cubi ricomposti e impilati occupano poco spazio.**

The peculiarity of SKUBI is the modularity of the pieces in a series of cubes, all "cut" in different ways. Reassembling and sort the cubes is a game. The reassembled and stacked cubes take up little space.

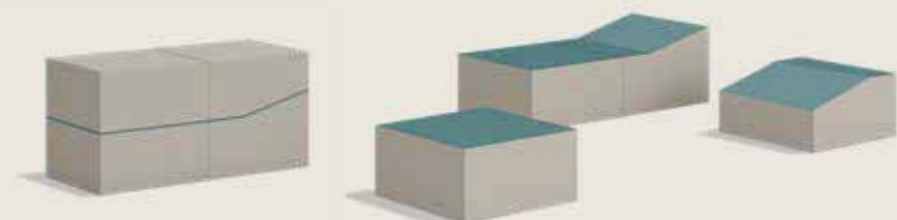

**DIMENSIONI**  
SIZES

**Tutti i cubi SKUBI misurano 60x60x60 cm. SKUBI 2x2 misura complessivamente 120x120x60 cm. SKUBI 3x3 misura complessivamente 180x180x60 cm.**

All SKUBI cubes measure cm 60x60x60. SKUBI 2x2 measures a total of cm 120x120x60. SKUBI 3x3 measures a total of cm 180x180x60.

**COLORI**  
COLORS

**I blocchi SKUBI giocano sul contrasto cromatico tra la superficie colorata del "taglio" e la tinta neutra delle facce esterne dei cubi. SKUBI è disponibile in due versioni: una con le superfici di taglio tutte gialle, una tutte petrolio. In entrambe le versioni, le superfici di taglio dei cubi con buco quadrato e con buco tondo sono rosse.**

SKUBI blocks play on the contrast between the colored surface of the "cut" and the neutral shade of the external faces of the cubes. SKUBI is available in two versions: with yellow or blue cutting surfaces. In both versions, the cutting surfaces of square-hole and round-hole cubes are red.



combinazione 01  
combination 01



combinazione 02  
combination 02

# SEDUTE MORBIDE

SOFT SEATS

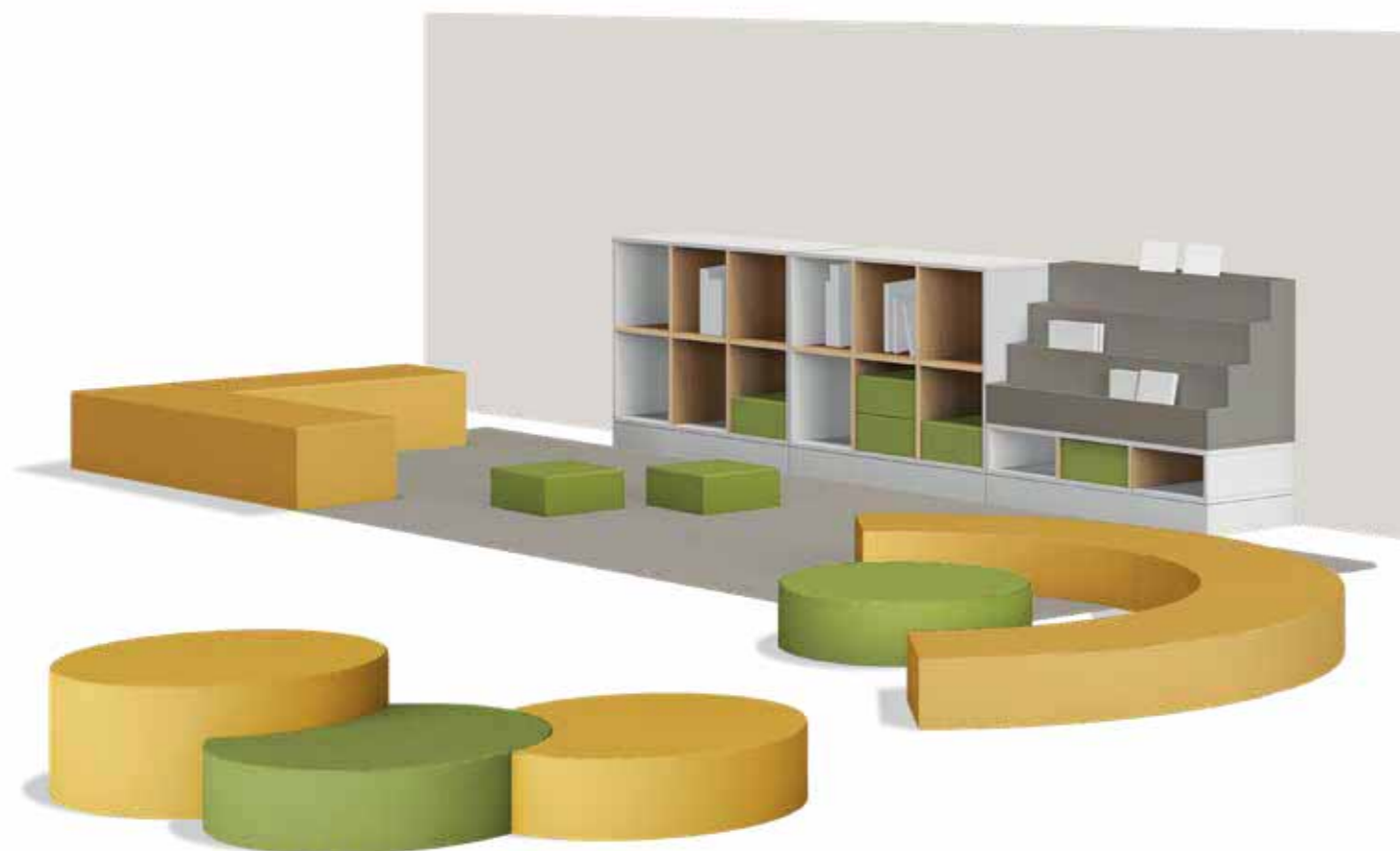

## SEDUTE MORBIDE

soft seats

**Pouf di varie geometrie e dimensioni coordinate con gli arredi SPAZIO ZERO6.**

Poufs of various shapes and sizes coordinated with SPAZIO ZERO6 furniture.

## DIMENSIONI

SIZES

**I pouf sono disponibili in due altezze: una adatta ai bambini da 1 a 3 anni, una per i bambini da 4 a 6.**  
**I pouf quadrati hanno dimensioni idonee all'inserimento nei vani dei contenitori.**

The poufs are available in two heights: one for children aged 1 to 3, one for children aged 4 to 6.  
 The square poufs have dimensions suitable for being placed into cabinet compartments.

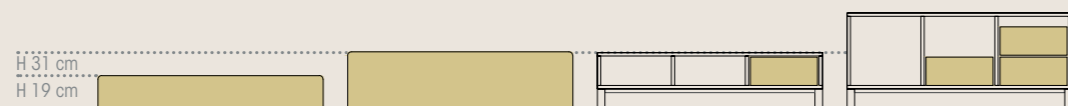

### POUF QUADRATO

square pouf morbido

36x36x15 cm **GAI300000**  
 45x45x19 cm **GAI300001**  
 45x45x31 cm **GAI300002**  
 80x80x19 cm **GAI300003**  
 80x80x31 cm **GAI300004**



### POUF RETTANGOLARE

rectangular pouf

80x45x19 cm **GAI300100**  
 80x45x31 cm **GAI300101**  
 120x45x19 cm **GAI300102**  
 120x45x31 cm **GAI300103**



### POUF TONDO

round pouf

Ø80x19 cm **GAI300200**  
 Ø80x31 cm **GAI300201**



### POUF LUNA MORBIDO

half-moon pouf

Ø80x19 cm **GAI300300**  
 Ø80x31 cm **GAI300301**



### POUF CURVO S

curved pouf - S

R55-100x45x19 cm **GAI300400**  
 R55-100x45x31 cm **GAI300401**  
 R65-100x35x19 cm **GAI300402**  
 R65-100x35x31 cm **GAI300403**



### POUF CURVO M

curved pouf - M

R100-145x45x19 cm **GAI300500**  
 R100-145x45x31 cm **GAI300501**



### POUF CURVO L

curved pouf - L

R145-190x45x19 cm **GAI300600**  
 R145-190x45x31 cm **GAI300601**



**Per inserimento all'interno dei contenitori curvi.**

For insertion inside the curved cabinets.



**Per disposizione allineata ai contenitori curvi.**

For alignment to curved cabinets.



**Per inserimento all'esterno dei contenitori curvi.**

For insertion outside the curved cabinets.

## COLORI

COLORS

**Tutti i pouf sono disponibili nella palette di colori degli imbottiti GAM.**

All poufs are available upon GAM upholstery color chart.

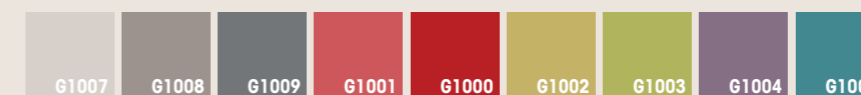

OUTDOOR

OUTDOOR



**OUTDOOR**  
OUTDOOR

**Nuovi arredi e oggetti OUTDOOR realizzano allestimenti originali di giardini e spazi all'aperto. Semplici elementi componibili offrono occasioni per attività e giochi. Nulla è rigidamente definito. Tutto è aperto a interpretazioni e variazioni. Ogni allestimento cerca nuove relazioni con gli elementi naturali: terra, alberi, cielo.**

OUTDOOR new furnishings and items create original settings for gardens and outdoor areas. Simple modular elements identify areas for new learning opportunities, activities and games. Nothing is rigidly defined. Everything is open to interpretations and variations. Each installation seeks new connections with the natural elements: earth, trees, sky.



**PEDANE, TELAI, PIKOUT**  
PLATFORMS, FRAMES, PIKOUT

**Tre serie di oggetti caratterizzano la nuova linea OUTDOOR. Prodotti semplici, molto versatili, che realizzano allestimenti inconsueti.**

Three product lines characterize the new OUTDOOR range. Simple, very versatile items that create unusual setups.

# OUTDOOR PEDANE, TAVOLI E SEDUTE

OUTDOOR  
PLATFORMS,  
TABLES AND SEATS



## PEDANE platforms

**Pedane di tre altezze compongono superfici di poco sopraelevate, per incontrarsi, raccogliere materiali del giardino, giocare, saltare ... Ci si può stare seduti, sdraiati, in piedi. Si può stare per terra e usarle come tavoli giapponesi. Disposte a fianco o intorno a un albero, formano luoghi accoglienti.**

Platforms of three heights create slightly raised surfaces for meeting, collecting garden materials, playing, jumping... You can sit, lie down, or stand. You can sit on the floor and use them as Japanese tables. Placed next to or around a tree, they form welcoming places.



## TAVOLI E SEDUTE tables and seats

**Tavoli e sedute sono arredi di disegno lineare e leggero. La base è in acciaio zincato, il piano in doghe di pino.**

Tables and seats feature a linear and light design. The frame is made of galvanized steel, the top is made of pine slats.

## DIMENSIONI SIZES

**Le pedane sono in tre altezze, che consentono di comporre superfici a gradoni. Tavoli e panche sono disponibili in due altezze, adatte ai bambini fino a 3 anni e da 4 a 6.**

The platforms are in three heights, which allow to create stepped surfaces. Tables and benches are available in two heights, suitable for children up to 3 years and from 4 to 6 years.

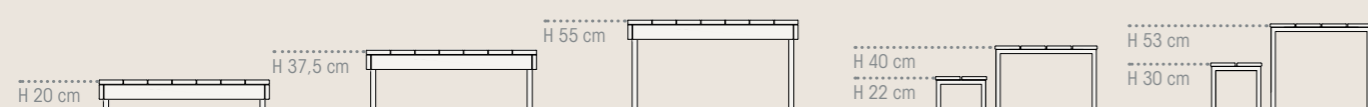

## PEDANA platform

200x100xh20 cm  
200x100xh37,5 cm  
200x100xh55 cm

GE0100433  
GE0100434  
GE0100452



## PAVIMENTO wooden flooring

m<sup>2</sup>/sq. m

GE0108200



## TAVOLO table

140x60xh40 cm  
140x60xh53 cm

GE0111500  
GE0111502



## PANCA bench

140x30xh22 cm  
140x30xh30 cm

GE0112500  
GE0112502



## PANCHETTO small bench

30x30xh22 cm  
30x30xh30 cm

GE0112600  
GE0112602

# OUTDOOR TELAI

OUTDOOR  
FRAMES



## TELAI frames

**I TELAI sono moduli elementari molto versatili. Sostengono pannelli, piani, barre, teli ombreggianti. Compongono strutture di varie dimensioni e complessità. Possibili giochi e attività sono appena accennati, aperti alle interpretazioni di bambini, educatori e insegnanti.**

The FRAMES are very versatile elementary module. They support panels, tops, bars, shade cloths. They make up structures of various sizes and complexity. Possible games and activities are just suggested, they remain open to the interpretations of children, educators, and teachers.

## DIMENSIONI SIZES

**Tutti i telai hanno le stesse misure in larghezza e altezza. Due tipi sono disponibili anche di altezza maggiore. TELAI alti e bassi contrapposti sono i sostegni ideali dei teli ombreggianti.**

All FRAMES have the same width and height. Two types are also available in higher height. High and low FRAMES, opposed to each other, are the ideal supports for the shade cloths.

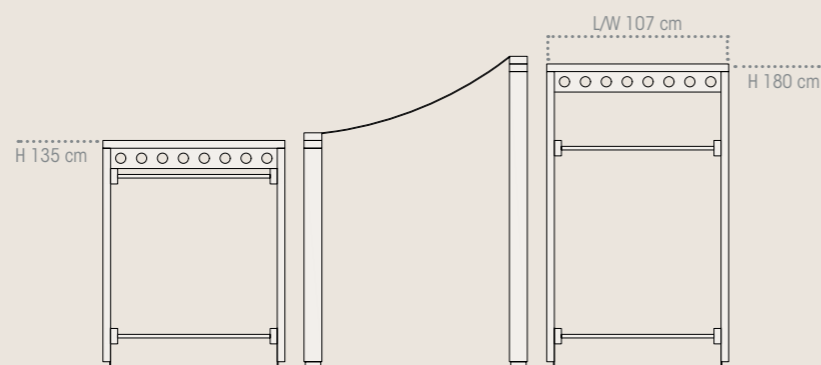

## TELAI PER ATTIVITÀ DIDATTICHE | FRAMES FOR EDUCATIONAL ACTIVITIES



**TELAIO LAVAGNA**  
blackboard frame

107x10,5xh135 cm **GE0100402**



**TELAIO LAVAGNA BIANCA**  
whiteboard frame

107x10,5xh135 cm **GE0100406**



**TELAIO PLEXIGLAS**  
plexiglas frame

107x10,5xh135 cm **GE0100425**



**TELAIO**  
frame

107x10,5xh135 cm **GE0100401**



**TELAIO PANNELLO FORATO**  
perforated panel frame

107x10,5xh135 cm **GE0100412**



**TELAIO CORNICE FORATA**  
perforated perimeter frame

107x10,5xh135 cm **GE0100438**

## TELAI PER ATTIVITA' LUDICHE | FRAMES FOR PLAY ACTIVITIES



**TELAIO CON PIANO**  
worktop frame

107x50xh135 cm **GE0100428**



**TELAIO CON VASCA**  
basin frame

107x50xh135 cm **GE0100429**



**TELAIO CON LAVELLO  
E RUBINETTO**  
sink and faucet frame

107x50xh135 cm **GE0100437**



**TELO OMBREGGIANTE**  
shade cloth

150x100 cm **GE0100442**

## TELAI PER ATTIVITA' MOTORIE | FRAMES FOR MOTOR ACTIVITIES



**TELAIO CON BARRA**  
bar frame

107x10,5xh135 cm **GE0100439**



**TELAIO CON DUE BARRE**  
2-bar frame

107x10,5xh135 cm **GE0100440**



**TELAIO ALTO CON BARRA**  
bar frame - high

107x10,5xh180 cm **GE0100430**



**TELAIO ALTO CON DUE  
BARRE**  
2-bar frame - high

107x10,5xh180 cm **GE0100441**

# OUTDOOR PIKOUT

OUTDOOR  
PIKOUT



## PIKOUT PIKOUT

**I PIKOUT sono microstrutture mobili. Sono tappe di percorsi da comporre, piccole tane, attrezzi ginnici. Girandoli e cambiando la faccia di appoggio a terra, diventano oggetti diversi. I PIKOUT interpretano i celebri oggetti inventati da Emmi Pikler in una versione originale, adatta al giardino.**

PIKOUTs are mobile microstructures. They are stages of a path, small dens, psychomotricity equipment. By turning them and changing the face that rests on the ground, they become different items. The PIKOUTs interpret Emmi Pikler's famous design pieces in an original version, suitable for outdoor activities.

## DIMENSIONI SIZES

**Le dimensioni dei PIKOUT sono adatte anche ai bambini più piccoli, che possono usarli come sostegno per i primi passi o come tunnel da attraversare gattonando.**

PIKOUTs sizes are suitable for smaller children, who can use them as support for the first steps or tunnels to crawl through.

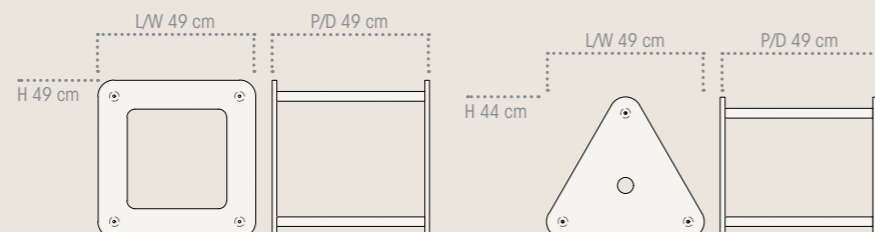

**PIKOUT FORI QUADRATI**  
PIKOUT - square holes

49x49x49 cm

**GE0100446**



**PIKOUT FORI TONDI**  
PIKOUT - round holes

49x49x49 cm

**GE0100445**



**PIKOUT FORI E ASOLE**  
PIKOUT - holes and slots

49x49x49 cm

**GE0100447**



**PIKOUT TRIANGOLARE FORI TONDI**  
PIKOUT - round holes

49x49x44 cm

**GE0100449**



**PIKOUT TRIANGOLARE FORI TONDI  
CON PLEXIGLAS COLORATO**  
PIKOUT - round holes with colored plexiglas

49x49x44 cm

**GE0100448**



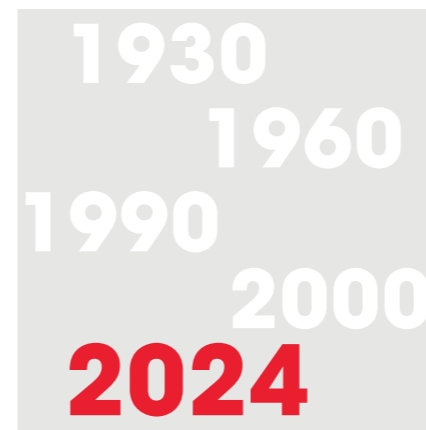

**GAM 1930 – 2024**  
GAM 19030 – 2024



**SELEZIONE ARTICOLI  
DEL CATALOGO 0-6**  
0-6 CATALOG – ITEMS SELECTION



**CERTIFICAZIONI**  
CERTIFICATIONS



1960



2024

1930

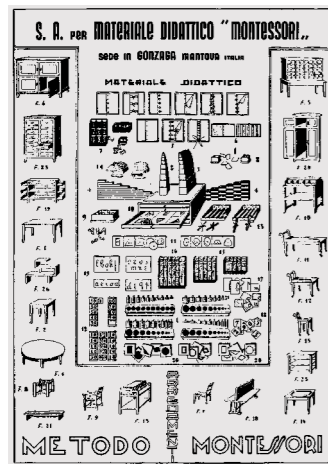

**Catalogo di materiali educativi e arredi disegnati con Maria Montessori per allestire le modernissime "case dei bambini". Gonzaga conquista fama mondiale per la creazione dell'ambiente per la pedagogia più avanzata.**

Catalog of educational materials and furnishings designed with Maria Montessori to set up ultra-modern "Children's Houses".

Gonzaga gains worldwide fame in setting up environments for the most advanced pedagogy.

1990



2000



**GAM presenta SPAZIO ZERO6. Arredi e oggetti per costruire spazi per crescere. Non una serie di mobiletti, ma sistemi per organizzare lo spazio, per offrire occasioni ai bambini. SPAZIO ZERO6 traduce l'esperienza, lunga un secolo, della realizzazione di innumerevoli nidi e scuole in una proposta nuova, che continua a tenere insieme buona pedagogia e buon design.**

GAM presents SPAZIO ZERO6. Furnishings and objects for spaces to grow in. Not a series of cabinets, but complete systems to set up learning environments. To organize the space and offer opportunities for children. SPAZIO ZERO6 translates the experience of a century in building countless nurseries and schools into a new proposal, which continues to hold good pedagogy and good design.



## SELEZIONE ARTICOLI DEL CATALOGO 0-6

### 0-6 CATALOG ITEMS SELECTION

**Una selezione di articoli del catalogo GAM 0-6 integra la nuova linea per completare l'offerta per nidi, scuole dell'infanzia, poli 06. Sono oggetti e arredi scelti per complementarità di funzioni e coerenza del design.**

A selection of items from the GAM 0-6 catalog integrates the new line to complete the offer for nurseries, kindergartens, primary schools. They are objects and furnishings chosen for their functional complementarity and design coherence.

ARTICOLI PER I PIÙ PICCOLI | ITEMS FOR THE YOUNGEST



**PRIMIPASSI CUBO MEDIUM**  
baby walker cubo medium

110x55xh55 cm **GA0280301**



**CHECUBO 1**  
CHECUBO 1

55X55XH55 cm **GA0282000**

**CHECUBO 2 CON SPECCHIO**  
CHECUBO 2 con specchio

55X55XH55 cm **GA0282001**



**FASCIATOIO CON SCALETTA**  
changing table with ladder

120x75xh85 cm sx | lh  
120x75xh85 cm dx | rh **GA0230003**  
**GA0230004**



**ALBERO DEI POMELLI 1**  
knob-tree 1

95xh150 cm **GA0272815**



**ALBERO DEI POMELLI 2**  
knob-tree 2

125xh150 cm **GA0272816**



**SEGGIOLINA PLURIUSO**  
all-purpose chair

34x32xh16/21/30 cm **GA0245300**  
riduttore | reducer **GA0245301**



**SEGGIOLINA PLURIPÌÙ**  
pluripiù chair

31,4x30xh36 cm **GA0245800**  
seduta | seat h16/21 cm **GA0245801**  
riduttore | reducer



**SPECCHIO A PARETE**  
wall mirror

127xh97 cm **GA0281300**  
40xh40 cm **GA0281301**  
60xh60 cm **GA0281302**  
60xh90 cm **GA0281303**  
140xh100 cm **GA0281305**



**SPECCHIO QUADRATO**  
square mirror

20x20 cm **GA0230800**



**SPECCHIO TRASFORMANTE**  
deforming mirror

40x6xh120 cm **GA0281800**



**TAVOLO PAPPÀ CURVO IN LEGNO**  
wooden curved table for babies

194x102xh52 cm **GA0242402**



**SEGGIOLONE IN LEGNO IMBOTTITO**  
padded wooden high-chair

46x47,5xh33/63 cm **GA0244000**



**TAPPETO IN TRET福德**  
tredford carpet

150x150 cm **GA0286400**  
150x200 cm **GA0286401**  
200x200cm **GA0286402**  
200x300 cm **GA0286403**  
Ø150 cm **GA0286404**  
Ø200 cm **GA0286405**  
170x50 cm **GA0286406**

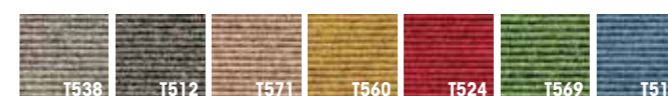

**TAPPETO IN MOQUETTE**  
moquette carpet

150x150 cm **GA0286200**  
150x200 cm **GA0286201**  
200x200cm **GA0286202**  
200x300 cm **GA0286203**  
Ø150 cm **GA0286204**  
Ø200 cm **GA0286205**

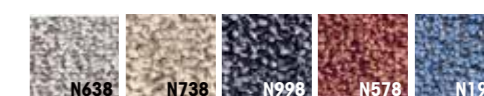



**CASAMIA**  
CASAMIA



**CASAMIA**  
casamia

185x115xh185 cm

**GA0264000**



**TELO BIANCO**  
white canvas sheet

208x107 cm

**GA0264010**



**GREEN CASAMIA**  
GREEN CASAMIA



**PANNELLO PORTAVASI**  
potholder panel

105xh55 cm

**GA0266063**

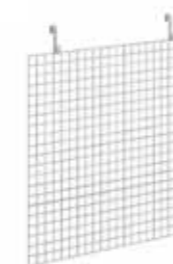

**GRIGLIA PORTAVASI**  
potholder grid

105xh55 cm

**GA0266064**



**SEDUTA CONTENITORE**  
container bench

105x27,5xh22 cm

**GA0264012**



**PANNELLO PORTALIBRI**  
book display pannel

105xh55 cm

**GA0264013**



**SEDUTA MORBIDA LINEARE**  
linear padded bench

105x27,5xh22 cm

**GAI000156**



**SCHIENALE**  
padded backrest

67x57xh44/78cm

**GC0001327**



**CASAMIA BIBLIO**  
CASAMIA BIBLIO



**POUF**  
pouf

Ø30xh22 cm

**GAI000155**



**CUSCINO**  
cushion

Ø30xh4 cm

**GAI000157**



**SEDUTA MORBIDA A ELLE**  
L-shaped padded bench

105x30/70xh8 cm

**GAI000154**



**TAPPETO**  
carpet

185x110 cm

**GA0286243**

GIOCO SIMBOLICO | PLAYROLE



**ANCH'IO\_CUCINO**  
I too\_cook

sopralzo | overhead frame  
105x45xh55/115 cm  
banco | worktop  
105x45/88,5xh115 cm

**GA0266010**

**GA0266011**



**ANCH'IO\_FACCIOAGGIUSTO**  
I too\_makefix

sopralzo | overhead frame  
105x45xh55/115 cm  
banco | worktop  
105x45xh55 cm

**GA0266020**

**GA0266021**



**ANCH'IO\_COMPROVENDO**  
I too\_buysell

sopralzo | overhead frame  
105x45xh55/115 cm  
banco | worktop  
105x45xh55 cm

**GA0266040**

**GA0266041**



**ANCH'IO\_LAVOSTIRO**  
I too\_washiron

sopralzo | overhead frame  
105x45xh55/115 cm  
banco | worktop  
105x45/88,5xh115 cm

**GA0266050**

**GA0266051**



**ANCH'IO\_CURO**  
I too\_lookaffer

105x45xh55/115 cm

**GA0266035**

ATELIER | ATELIER



**ALBERO DEI VASI**  
pot tree

Ø100xh123 cm  
Ø100xh143 cm

**GA0241525**  
**GA0241526**



**CAVALLETTO CONTENITORE SU RUOTE**  
container easel on wheels

75x62xh120 cm

**GA0275204**



**CAVALLETTO TRASPARENTE**  
transparent easel

75x52xh120 cm

**GA0275203**



**BANCO DEI TRAVASI**  
decanting bench

90x90xh55/120 cm

**GA0275206**



**TAVOLO LUMINOSO MULTICOLOR ALTO**  
high light table

75x75xh55 cm

**GA0243406**



**TAVOLO LUMINOSO MULTICOLOR BASSO**  
low light table

75x75xh23 cm

**GA0243407**



**PARETE 70**  
wall 70

105x10xh70 cm **GA0270000**



**OBLÒ 70**  
portholes 70

105x10xh70 cm **GA0270001**



**SPECCHIO 70**  
mirror 70

105x10xh70 cm **GA0270002**



**PARETE 100**  
wall 100

105x10xh100 cm **GA0271000**



**PASSAGGIO 100**  
passage 100

105x10xh100 cm **GA0271001**



**OBLÒ 100**  
portholes 100

105x10xh100 cm **GA0271002**



**OBLÒ-BUCHI 100**  
portholes-holes 100

105x10xh100 cm **GA0271003**



**BARRE 70**  
bars 70

105x10xh70 cm **GA0270003**



**LIBRI 70**  
books 70

105x10xh70 cm **GA0270004**



**BOLLE 70**  
bubbles 70

105x10xh70 cm **GA0270005**



**SPECCHIO 100**  
mirror 100

105x10xh100 cm **GA0271004**



**SPECCHIO PIXEL 100**  
mirror pixel 100

105x10xh100 cm **GA0271005**



**LIBRI 100**  
books 100

105x10xh100 cm **GA0271006**



**APPENDITUTTO 100**  
hangers 100

105x10xh100 cm **GA0271007**



**PORTELLO 70-100**  
hatch 70-100

105x10xh70 cm **GA0270006**  
105x10xh100 cm **GA0271018**



**FANALE DI CODA 70-100**  
taillight 70-100

45xh100 cm **GA0270007**  
60xh100 cm **GA0271015**



**CONTENITORE**  
box

25x25xh25cm **GA0271011**



**MENSOLA**  
shelf

37x14,5xh14,5 cm **GA0271012**



**DISEGNO**  
drawing

85,3x14,5xh56,5 cm **GA0271013**



**LAVAGNA**  
blackboard

85,3xh56,5 cm **GA0271014**

MORBIDI | SOFT



**GIANT'S**  
giant's

120x120xh14/24/34/44 cm

**GAI222200\***

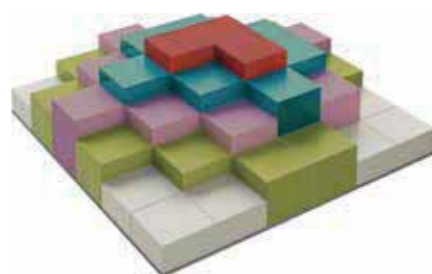

**GIANT'S GRANDE**  
big giant's

180x180xh14/24/34/44/54 cm

**GAI222400\***



**MATERASSO QUADRATO**  
mat

60x60xh5 cm  
90x90xh5 cm  
100x100xh5 cm  
120x120xh5 cm  
150x150xh5 cm  
200x200xh5 cm

**GAI200100**  
**GAI200200**  
**GAI200300**  
**GAI200400**  
**GAI200500**  
**GAI200600**

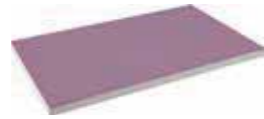

**MATERASSO RETTANGOLARE**  
mat

50x100xh5 cm  
60x90xh5 cm  
60x120xh5 cm  
60x150xh5 cm  
60x180xh5 cm  
90x120xh5 cm  
90x150xh5 cm

**GAI201000**  
**GAI201100**  
**GAI201200**  
**GAI201300**  
**GAI201400**  
**GAI201500**  
**GAI201600**

90x180xh5 cm  
100x200xh5 cm  
120x180xh5 cm  
130x200xh5 cm  
150x200xh5 cm  
120x150xh5 cm

**GAI201700**  
**GAI201800**  
**GAI201900**  
**GAI202000**  
**GAI202100**  
**GAI202200**



**MATERASSO ANGOLARE**  
corner mat

60x60xh5 cm  
90x90xh5 cm  
120x120xh5 cm

**GAI202500**  
**GAI202600**  
**GAI202700**

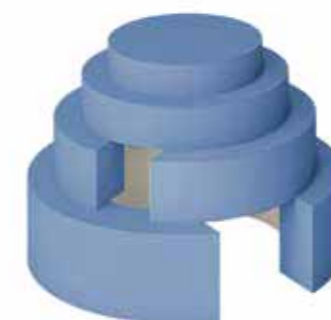

**IGLÙ S**  
iglù S

Ø120xh84 cm

**GAI223501**

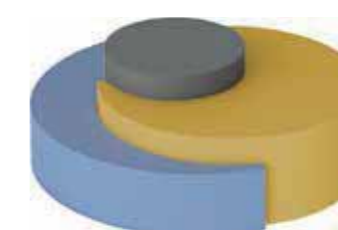

**ECLISSE S**  
eclisse S

Ø120xh40 cm

**GAI223301\***



**TANULLA**  
tanulla

105x70xh26 cm  
materasso | mat  
set lenzuola | sheet

**GAI290000**  
**GAI290100**  
**GA0291603**

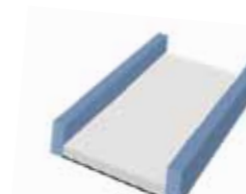

**LETTINO MORBIDO**  
soft bed

100x60xh7/15 cm  
lenzuolo | sheet  
120x60xh7/15 cm  
set lenzuola | sheet

**GAI290200**  
**GA0291620**  
**GAI290300**  
**GA0291622**



**POLTRONCINA KUARK**  
kuark armchair

67x57xh44/78 cm  
cuscino | cushion  
41x44 cm

**GC0001326**  
**GC0001327**



**MATERASSO ROTONDO**  
round mat

Ø60xh5 cm  
Ø120xh5 cm  
Ø200xh5 cm

**GAI203000**  
**GAI203100**  
**GAI203200**



**MATERASSO AD INCASTRO**  
mat

Ø60xh5 cm  
Ø200xh5 cm

**GAI203500**  
**GAI203600**



**SET ARCOBALENO**  
rainbow set

Ø60xh5 cm

**GAI203700\***



**POLTRONCINA**  
armchair

45x50xh24/46 cm  
45x50xh30/54 cm  
60x60xh42/72 cm  
60x60xh42/72 cm  
40 kg/mc

**GAI215400**  
**GAI215401**  
**GAI215402**  
**GAI215405**



**CUSCINO MONOCOLORE**  
one-color cushion

40x40 cm  
60x60 cm

**GAI206000**  
**GAI206100**



**CUSCINO BICOLORE**  
two-color cushion

120x120 cm

**GAI206200**



**CUSCINO ROTONDO MONOCOLORE**  
one-color cushion

Ø60 cm

**GAI206500**



**CUSCINO ROTONDO BICOLORE**  
two-color cushion

Ø90 cm  
Ø120 cm

**GAI206600**  
**GAI206700**

**COLORI**  
COLORS

**morbidi**  
padding

G1007	G1008	G1009	G1001	G1000	G1002	G1003	G1004	G1005
			G1032	G1039	G1021	G1022	G1023	G1024
			G1028	G1038		G1025	G1026	G1027

**iglù S**  
iglù S

G1006	interno inside G1007	G1007	interno inside G1006
combinazione 01 combination 01		combinazione 02 combination 02	

**tanulla**  
tanulla

G1007	G1003	G1005	G1006
-------	-------	-------	-------

\* disponibile solo nei colori indicati nell'immagine  
only available in the colors shown in the picture



**CERTIFICAZIONI**  
CERTIFICATIONS

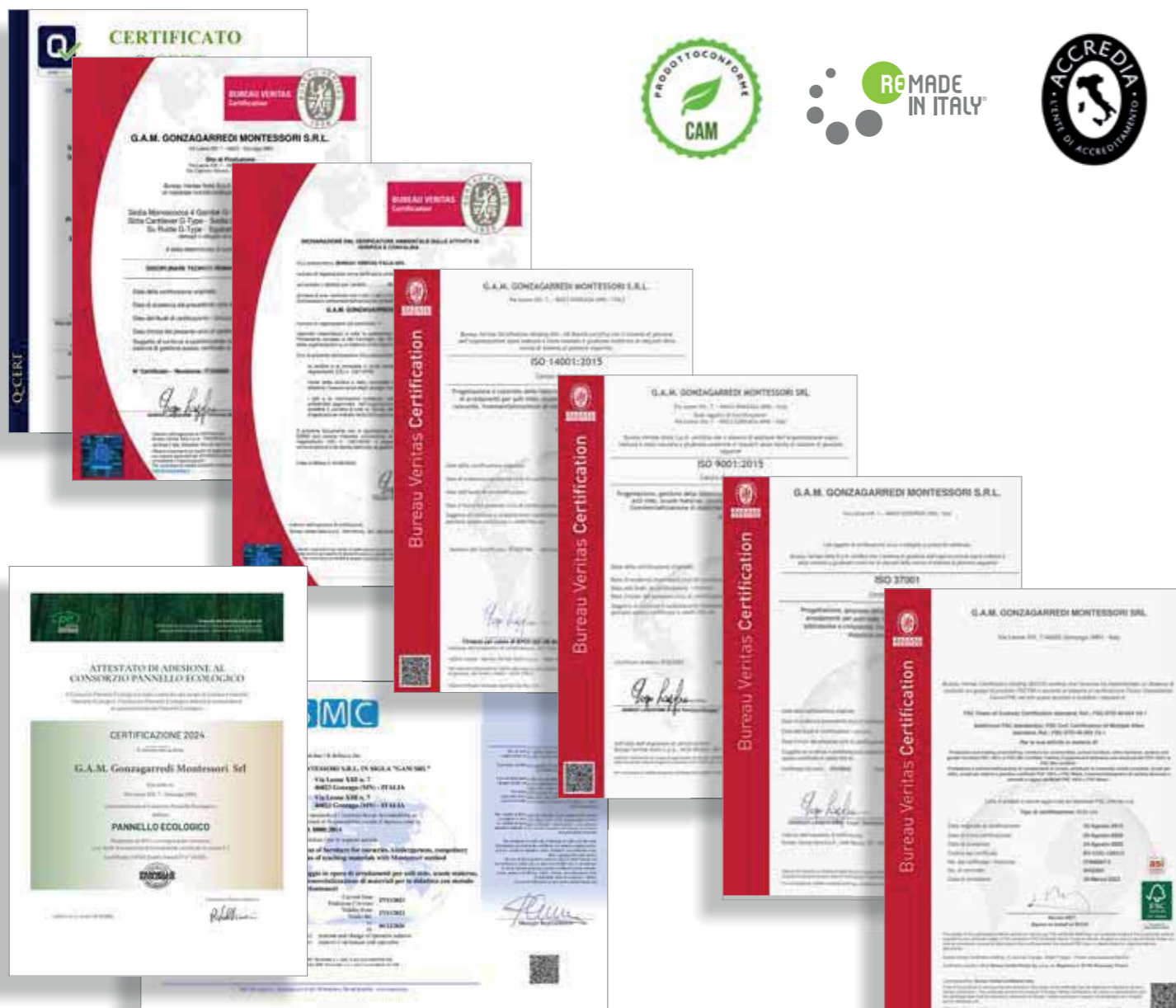

**I prodotti GAM sono conformi alle norme tecniche del settore. Sono testati per sicurezza, resistenza e non tossicità. Vernici e coloranti sono atossici, contenuto di formaldeide in classe E1, imbottiti in classe di reazione al fuoco 1IM, su richiesta arredi lignei in classe 1. I prodotti GAM sono conformi ai CAM (Criteri Ambientali Minimi).**

All GAM products comply with the technical standards of the sector. They are tested for safety, resistance and non-toxicity. Paints and colours are non-toxic, class E1 formaldehyde content, 1IM fire rating upholstery; class 1 wooden furnishing on request. GAM products comply with CAM (minimum environmental criteria).





Product design, art direction, copywriting – **Giovanni Fumagalli**  
**cc91 design & research**

Architectural and product design - **Lorenzo Caporro, Edoardo Valenti**

Graphic design – **Simona Malizia**

I disegni sulle pareti nelle ambientazioni sono citazioni di Bruno Munari.

**ARREDI PER SCUOLE  
E SERVIZI PER L'INFANZIA  
ARREDI PER BIBLIOTECHE  
MATERIALI MONTESSORI  
EARLY-YEARS FURNITURE  
SCHOOL FURNITURE  
LIBRARY FURNITURE  
MONTESSORI MATERIALS**

